

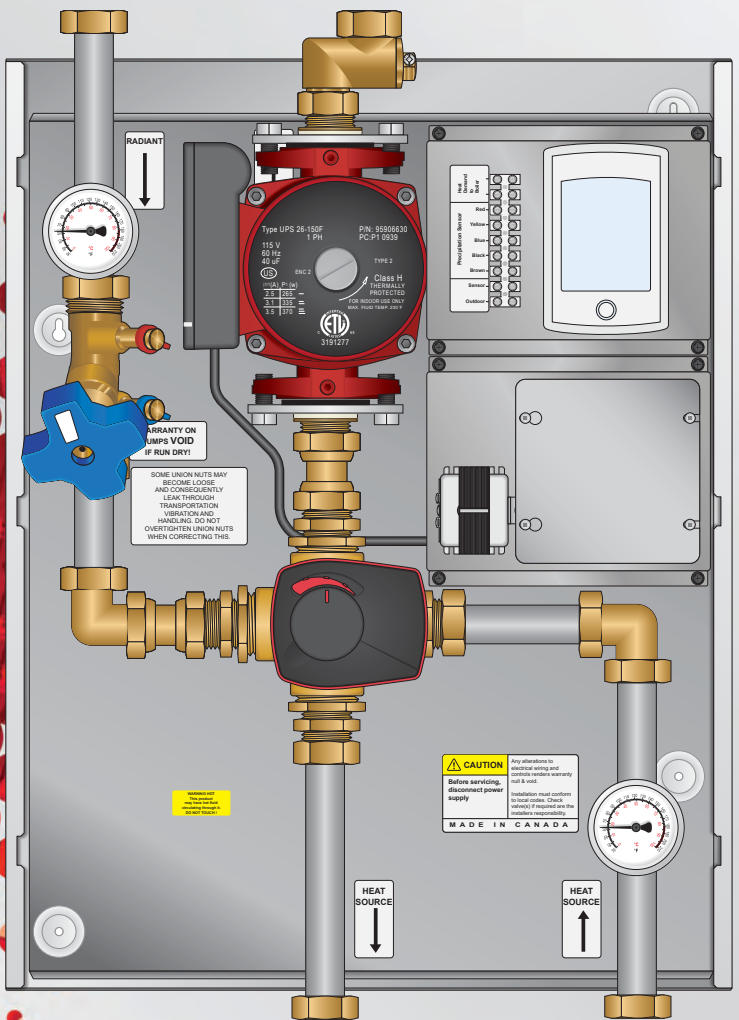

4WMIX-654

Installation, Operation, and Maintenance Manual



| | |
|---------------------------------------|----|
| Product Safety Information..... | 4 |
| Warnings..... | 4 |
| Servicing..... | 4 |
| Function..... | 4 |
| Unpacking..... | 5 |
| Installation Tools Needed | 5 |
| Panel Components..... | 6 |
| Panel Components..... | 7 |
| Panel Component Specifications..... | 8 |
| Pump Technical Data..... | 8 |
| Pump Curves..... | 9 |
| Panel Mounting | 11 |
| Piping Hookup..... | 12 |
| Fill & Purge | 13 |
| Troubleshooting - Error Messages..... | 23 |

Disclaimer

HeatLink Group Inc. shall not be responsible for errors in its brochures or printed materials. HeatLink Group Inc. reserves the right to alter its products at any time without notice, provided that alterations to products already on order shall not require material changes in specifications previously agreed upon HeatLink Group Inc. and the Purchaser. All trademarks in this material are property of the respective companies. HeatLink and the HeatLink logotype are trademarks of HeatLink Group Inc. All rights reserved.

Product Safety Information

Warnings

The zone control panel is for indoor use only and must be installed by a qualified installer/service technician. This product must be installed and operated in strict accordance with the terms set out in this manual and in accordance with the relevant requirements of the Local Authority Having Jurisdiction. Failure to comply will result in a void of warranty, and may also result in property damage, serious injury, or death.

Servicing

Prior to commencing installation of this panel it is necessary to read and understand all sections of this manual. The symbols below are used throughout this document to ensure proper operation of the panel, and your safety. Please pay attention to these symbols.



Warning
Possible Hazard



Warning
Live Power



Warning
Hot Pipes



Warning
Treated Water



In order to avoid injury or death, switch off the power to the panel prior to inspecting or making connections to the terminal strip.

Function

This zone control panel can provide mixing, distribution, and zoning for a wide variety of hydronic heating applications.

The effectiveness of the system is dependant on the system being designed and installed correctly. Proper consideration of factors such as BTU loads, outdoor design temperature, indoor design temperature, room set-point temperature(s), differential fluid temperatures, head loss, flow rates, and transfer capacities of the heat emitters is critical.

Once these factors have been considered and the system requirements determined, these can then be evaluated and compared to the panel capabilities.

Note:

Unpacking

- Step 1** Examine carton for any damage that may have occurred during shipping. If damage is visible notify your courier and supplier immediately.
- Step 2** Open the carton by removing the staples.
- Step 3** Remove the cardboard spacers from the carton, then remove the panel from the carton. Lift the panel by the base, not the enclosure.
- Step 4** Remove the enclosure from the panel [panel specific instructions].

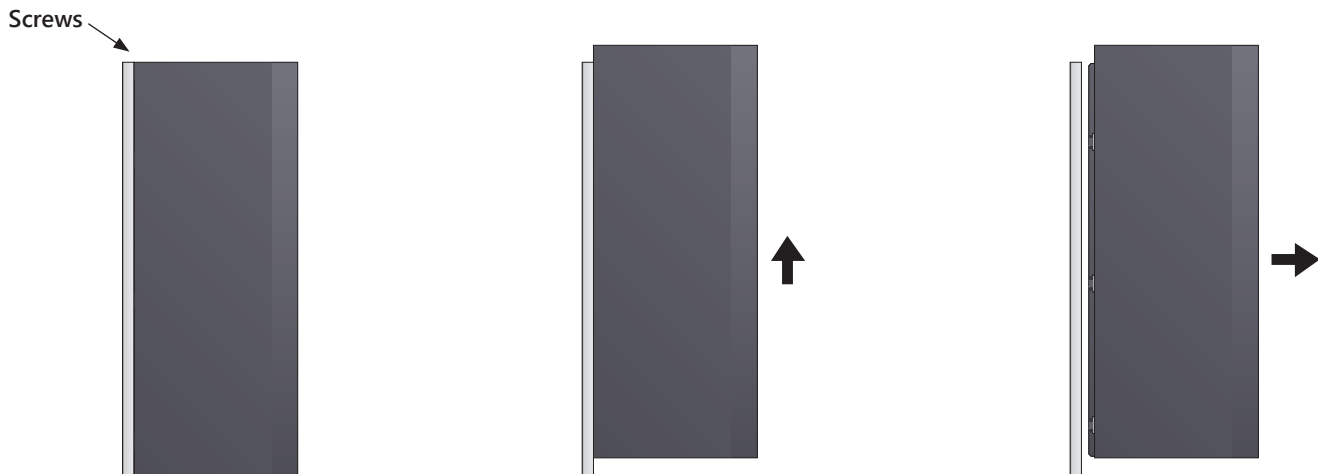

Installation Tools Needed

- Level
- Screwdriver or power drill
- Flat head bit
- Phillips head bit # 2
- 2 adjustable wrenches (or 2 × 30mm wrenches)

Panel Components

| # | Components | Component Description | Part Number | |
|----|-----------------------------|---|-------------|-------------|
| | | | 4WMIX-654 | 4WMIXHH-654 |
| 1 | Secondary pump | Moves the heated fluid through the system when there is a call for heat from the system controller. | UPS26-99 | UPS26-150 |
| 2 | 1¼" Mixing valve (hidden) | 4-way brass mixing valve regulates the temperature in the hydronic system with the help of the electric motor actuator and system controller. | | 64031 |
| 3 | DDC Mixing Valve Motor | Mounted to the control valve and moves the valve appropriately to allow the heated fluid to enter. Works in conjunction with the system controller. | | 58132 |
| 4 | Snow Melt control | The system controller regulates the panel operation. | | 30654 |
| 5 | Return sensor | Temperature sensor on the system return piping. | | |
| 6 | Supply sensor | Temperature sensor on the system supply piping. | | |
| 7 | 24V(ac) transformer | Converts power for the Snow Melt Control. | | n/a |
| 8 | Electrical Box | Houses transformer wiring. | | n/a |
| 9 | Balancing valve | Adjusts flow. | | n/a |
| 10 | Thermometer | Shows system temperature. | | n/a |
| 11 | Isolation valve assemblies* | Zone valve used to isolate the panel from the system during fill & purge, and maintenance. | | n/a |

*Packaged in accessory box for shipping. See page 10 for piping hookup instructions.

Panel Component Specifications

| | 4WMIX-654 | 4WMIXHH-654 |
|----------------------------------|---|-------------------------------|
| Listing | cETLus | |
| Conforms to | CAN/CSA-C22 No.14, UL508 | |
| Dimensions | 24"H × 18¾"W × 8"D | |
| Weight | | |
| Max ambient temperature | 120°F | |
| Max water temperature | 200°F | |
| Settable fluid temperature range | 100-145°F | |
| Power supply | 120V(ac) | |
| Pump | Ferrous, Grundfos UPS26-99FC | Ferrous, Grundfos UPS26-150FC |
| Auxiliary terminal | none | |
| Temperature control method | 1-1/4" 3-Way Mixing Valve and DDC Motor | |
| Temperature control range | | |
| Mixing valve Cv | 18.7 | |
| Piping | 1" 304 stainless steel tubing, 1" brass | |
| Piping connections | 1½" MNPT | |
| Backplate | Galvanized steel | |
| Enclosure | Powder coated steel | |

Pump Technical Data

| | Model Number | |
|---|---|-------------------------|
| | UPS 26-99FC | UPS 26-150F |
| Material | | |
| Inlet cone, bearing plate, bearing retainers, rotor can, rotor cladding, shaft retainer | Stainless steel | |
| Stator housing | Aluminum | |
| Shaft, upper and lower radial bearings | Aluminum oxide ceramic | |
| Thrust bearing | Carbon bearing and EPDM retainer | |
| Check valve | ACETA with 302 SS spring and nitrile rubber seats | |
| Pump housing (volute) | Cast iron | |
| O-ring and gaskets | EPDM | |
| Impeller | PES composite (30% glass filled) | |
| Terminal box | Noryl® with EPDM gasket | |
| Flow range | 0-33 US gpm (0-7.5 m³/h) | 0-53 US gpm (0-12 m³/h) |
| Head range | 0-29 ft(0-8.8 m) | 0-46 ft (0-14 m) |
| Motors | 2-pole, single phase | |
| Max. liquid temperature | 230°F (110°C) | |
| Min. liquid temperature | 36°F (2°C) | |
| Max. system temperature | 145 psi (10 bar) | |

Pump Curves

The pump moves the heated fluid through the system when there is a call for heat from the system controller.



The addition of glycol to the system will result in higher demand from the pump due to the change in viscosity of the fluid.

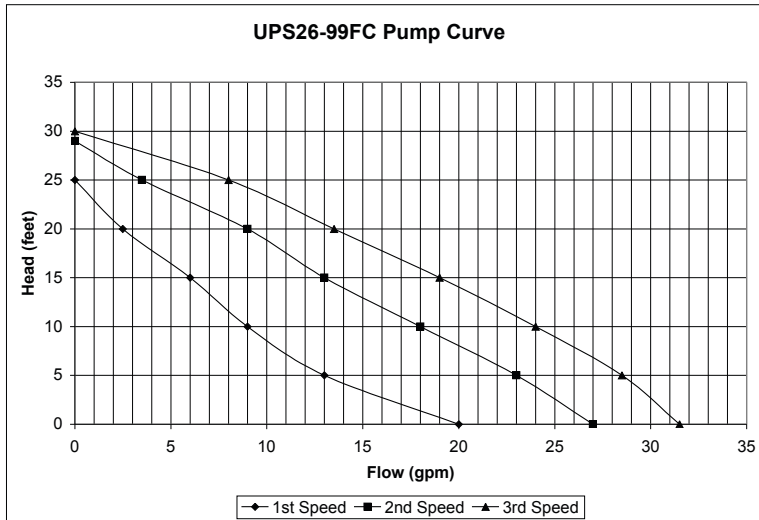

| Speed | Volts | Amps | Watts | Hp | Capacitor |
|-------|-------|------|-------|-----|------------|
| 3 | 115 | 1.8 | 197 | 1/6 | 20 μF/180V |
| 2 | | 1.5 | 179 | 1/6 | |
| 1 | | 1.3 | 150 | 1/6 | |

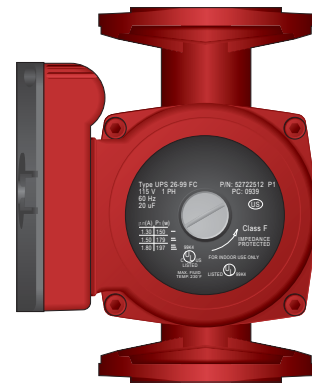

| Speed | Volts | Amps | Watts | Hp | Capacitor |
|-------|-------|------|-------|-----|------------|
| 3 | 115 | 3.5 | 370 | 1/6 | 40 μF/180V |
| 2 | | 3.1 | 335 | 1/6 | |
| 1 | | 2.5 | 265 | 1/6 | |

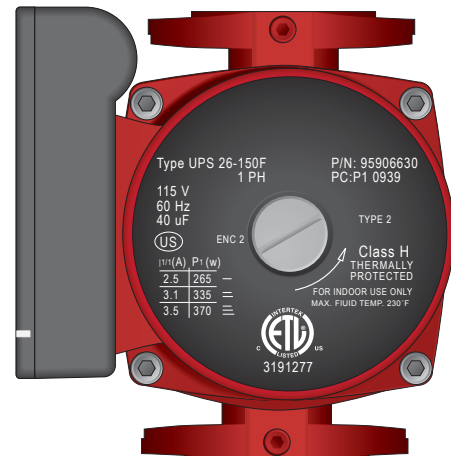
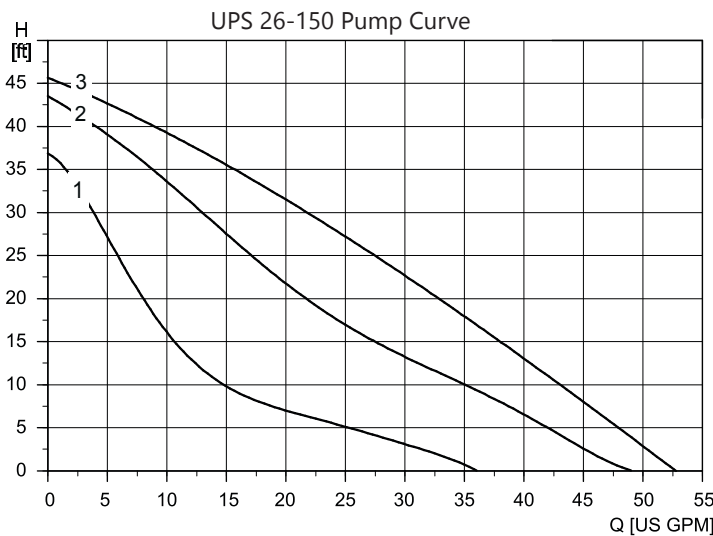

Control Valve

4-way brass mixing valve regulates the temperature in the hydronic system with the help of the electric motor actuator and system controller.

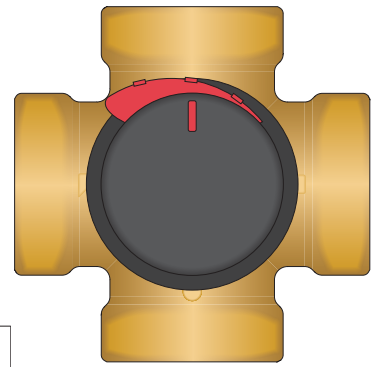

Technical Data - 4-way mixing valve

| | |
|--------------------------------------|------------------|
| Material - Valve Body & Slide: | Brass DZR |
| Material - Shaft & Bushing:..... | PPS composite |
| Material - O-ring:..... | EPDM |
| Max. Operating Temperature: | 230°F (110°C) |
| Min. Operating Temperature:..... | -15°F (-10°C) |
| Max. Operating Pressure: | 145 psi (10 bar) |
| Max. Differential Pressure: | 14.5 psi (1 bar) |
| Leaking in % of flow*:..... | <1.0% |
| Max. Torque: | <44lbf*in (<5Nm) |

*based on diff. pressure of 14.5 psi (1 bar)

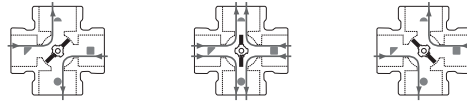
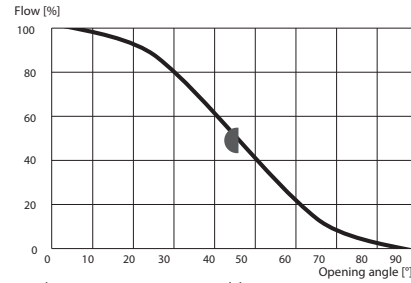

Mixing Valve Motor

The mixing valve motor is mounted to the control valve and moves the valve appropriately to allow the heated fluid to enter. This motor works in conjunction with the system controller.

Manual Operation of Mixing Valve Motor

NOTE: Mixing Valve Motor should not be placed in manual mode for an extended period of time.

- Pull knob out on motorized actuator.
- Rotate knob clockwise or counter-clockwise.
- To return to automatic mode, push the knob in.



Technical Data - DDC Mixing Valve Motor

| | |
|--|------------------------------|
| Ambient Temperature: | max. 131°F (55°C) |
| | min. 23°F (-5°C) |
| Power Supply:..... | 24±10% Vac/dc, 50/60 Hz |
| Enclosure Rating:..... | IP41 |
| Protection Class:..... | II |
| Torque:..... | 6 Nm |
| Power Consumption - Operation:..... | AC: 5W |
| | DC: 2.5W |
| Power Consumption - Dimensioning:..... | AC: 8 VA |
| | DC: 4 VA |
| Rating Auxiliary Switch: | 6(3)A 250Vac |
| Running Time 90°: | 45/120 sec |
| Control Signal..... | 0-10V, 2-10V, 0-20mA, 4-20mA |

The motor should be preceded by a multi-pole contact breaker in the fixed installation.

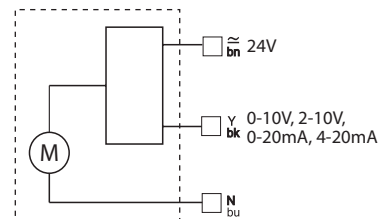

CE LVD 2006/95/EC
EMC 2004/108/EC
RoHS 2002/95/EC

Panel Mounting

Prior to mounting the panel, ensure the wall is capable of supporting the weight of the panel, and that all required power outlets and/or wiring is available at the installation location.

- Step 1** Determine the location and distance between the wall studs. With a level at a minimum height of 4' from the floor, draw a straight line and mark the stud locations. If the panel cannot be secured directly to the studs, or suitable backing boards, plywood may need to be installed behind the panel to properly secure it in place.
- Step 2** Screw two of the supplied mounting screws into the wall studs (or backing plywood) 3/4" and 6 1/2" from the top of the desired height, and 16" apart, leaving 1/4" of the screw out from the wall.
- Step 3** Lift and place the panel onto the mounting screws. Two person lift may be required.
- Step 4** Screw the remaining mounting screws into the holes at the bottom of the panel, and tighten the top two screws.

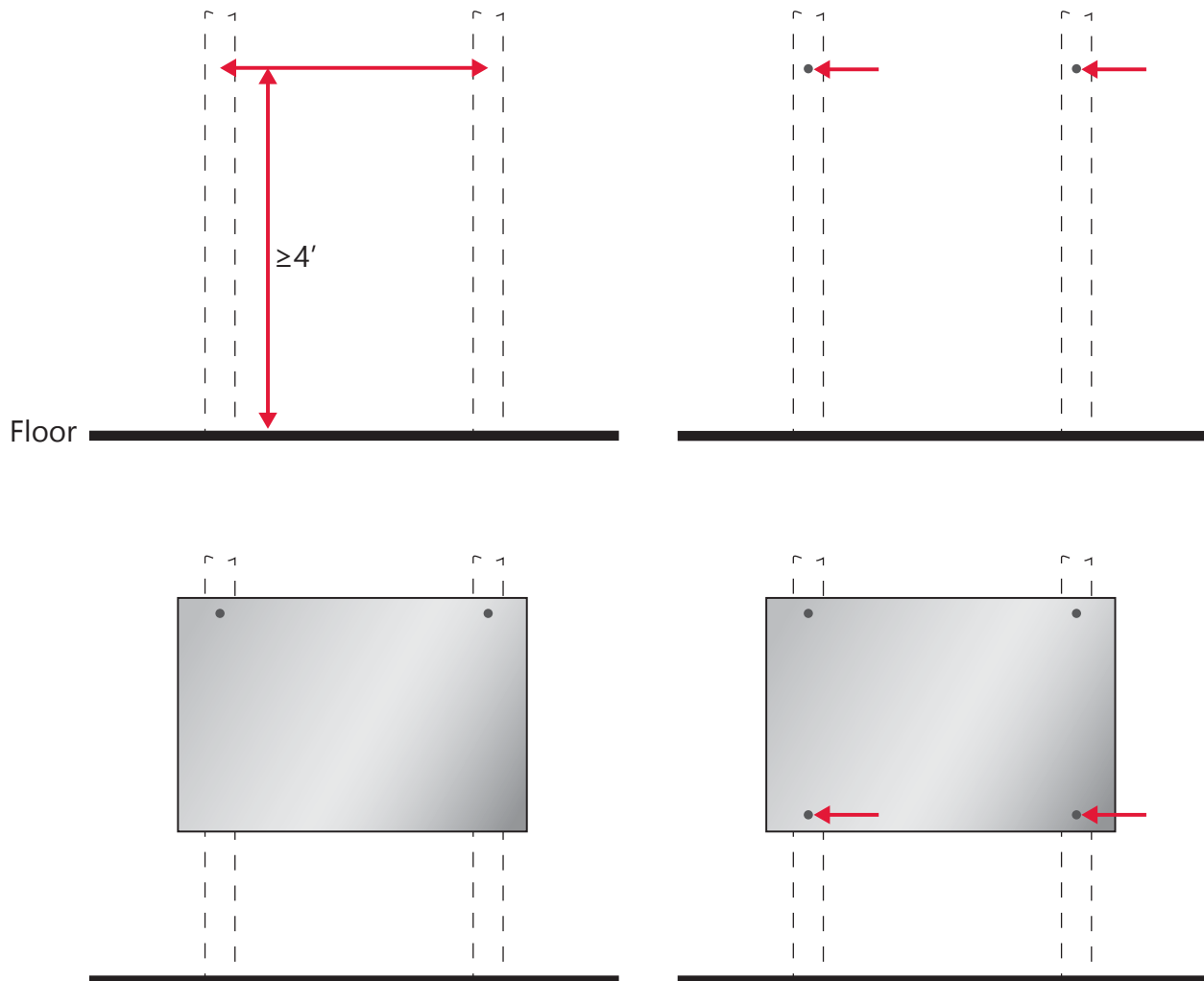

Piping Hookup

The 4WMIX-SMCP ships with the adapter assemblies packaged in the accessory pack, and must be connected to the panel *after* the system connections have been made.

- Step 1** Piping connections are 1-1/2" MNPT. Use appropriate thread sealant and backup wrench when making connections.
- Step 2** Connect adapter assemblies to the panel. The supplied washers must be used, and nuts must not be overtightened as this may damage the washers.

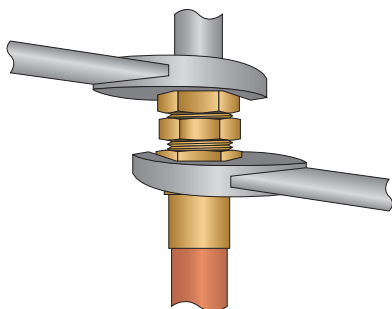
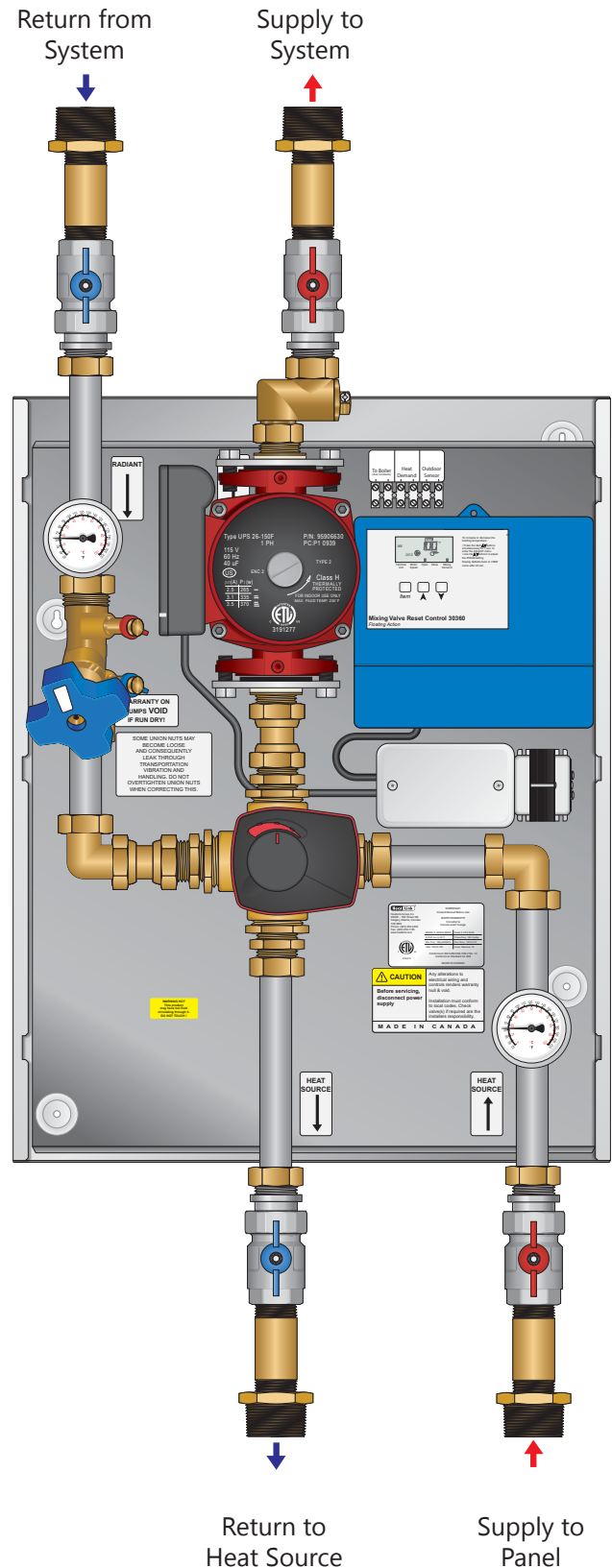

*Always use a Backup Wrench
Do not overtighten brass nuts!*

Fill & Purge

- Step 1 Ensure the panel is not connected to the power source.
- Step 2 Fully open the mixing valve.
- Step 3 Close all isolation ball valves, and attach the fill and purge hoses (not included) to the system fill and purge valves. Open valves.
- Step 4 Open isolation valves and allow water to run until it is free of bubbles.
- Step 5 Close system fill and purge valves.
- Step 6 Detach fill and purge hoses.
- Step 7 Check for leaks at connections. If any leaks are found, use a back-up wrench and carefully tighten until the leak stops. **Do not overtighten!**

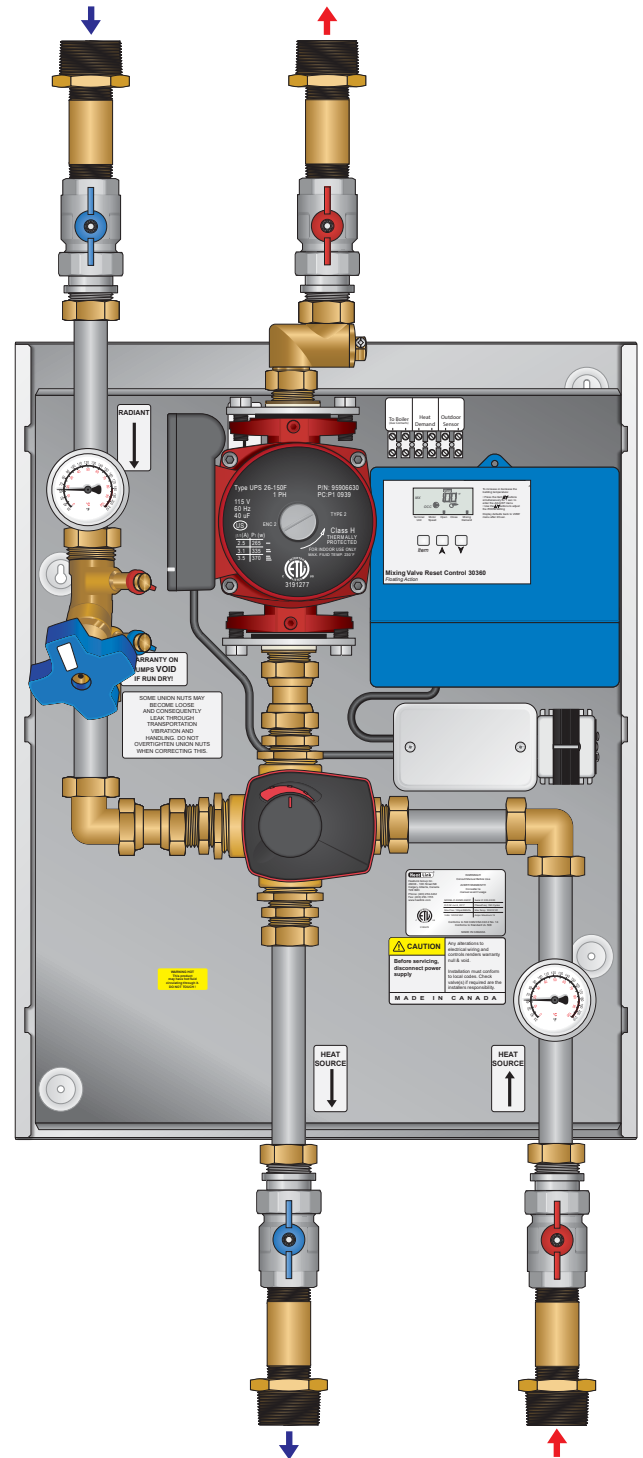

Piping Options

Option #1: Parallel Primary/Secondary

Pros:

- Supply water temperature the same for each load
- No possible pump interference

Cons:

- Requires additional balancing valves for each load take off.
- Hot water migration/gravity flow possible in return riser. Flow check, Spring loaded check valve or thermal trap required in return riser.
- Critical on site installation (Tee spacing and pipe sizing)
- Complex piping

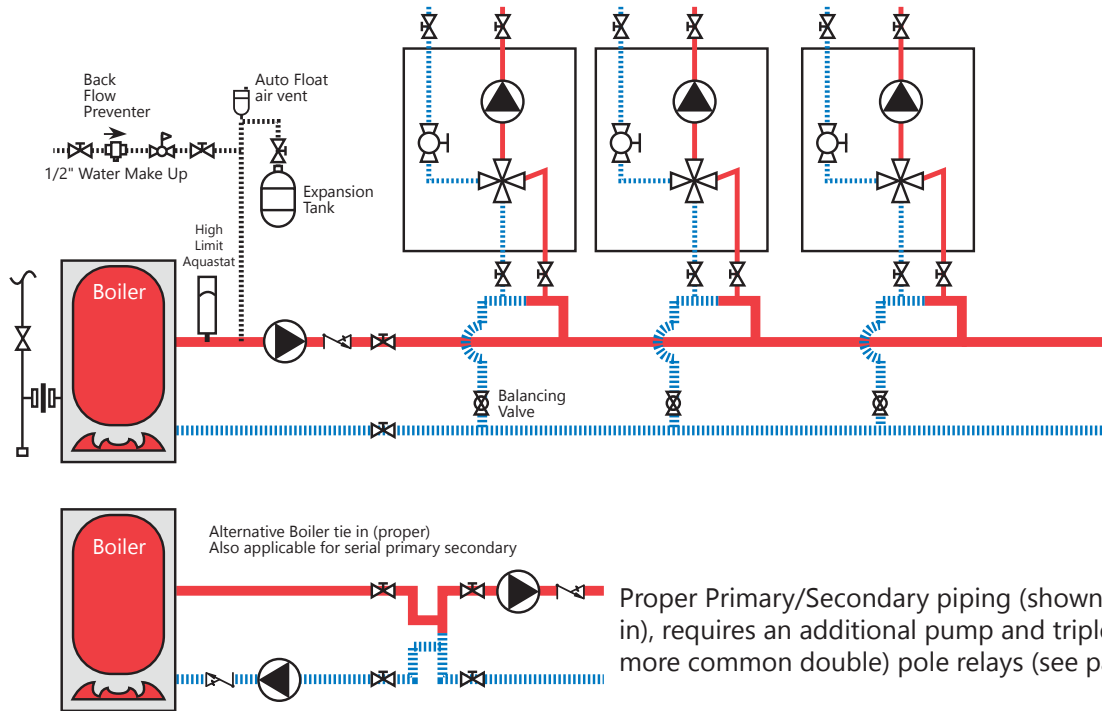

Option #2: Series Primary/Secondary

Pros:

- Automatic priority
- No possible pump interference

Cons:

- Supply water temperature lowers for each load, this change of temperature is not constant. Some loads may not function if temperature is too low.
- Very expensive to alter priority sequence (note: all loads are prioritized)
- Hot water migration/gravity flow possible in return line. Flow check, Spring loaded check valve or thermal trap required in return riser.
- Critical on site installation (Tee spacing and pipe sizing)

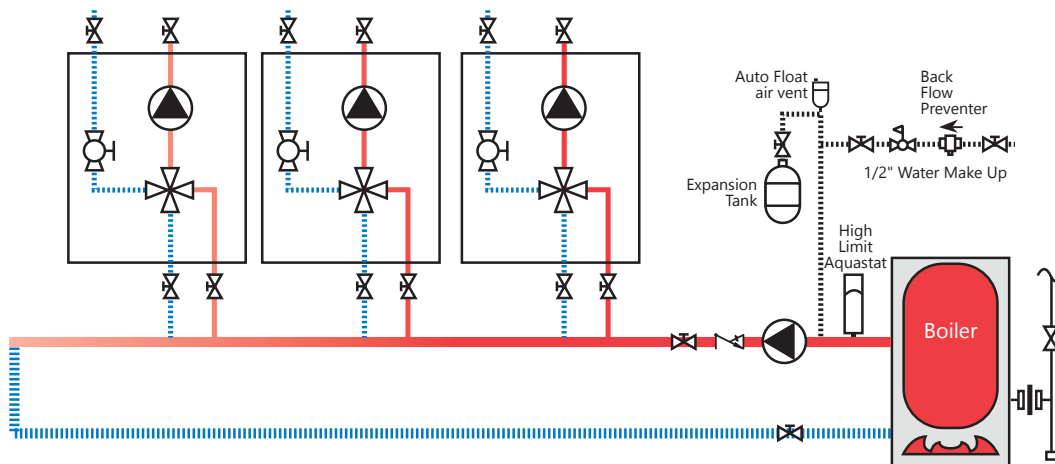

Panel Wiring



- Wiring should be done by a qualified electrician and should meet local codes and jurisdictions.

The panel comes with an optional boiler return sensor which can be used instead of an outdoor sensor. If used the mixing valve will provide boiler return protection to the boiler inlet by closing the valve when the boiler return temperature falls below the Boiler Minimum setting. Boiler return protection requires the installation of a boiler return sensor 082 on the inlet to the boiler and the Outdoor/Boiler Return Sensor setting must be set to Boiler Return.

Wiring Diagram

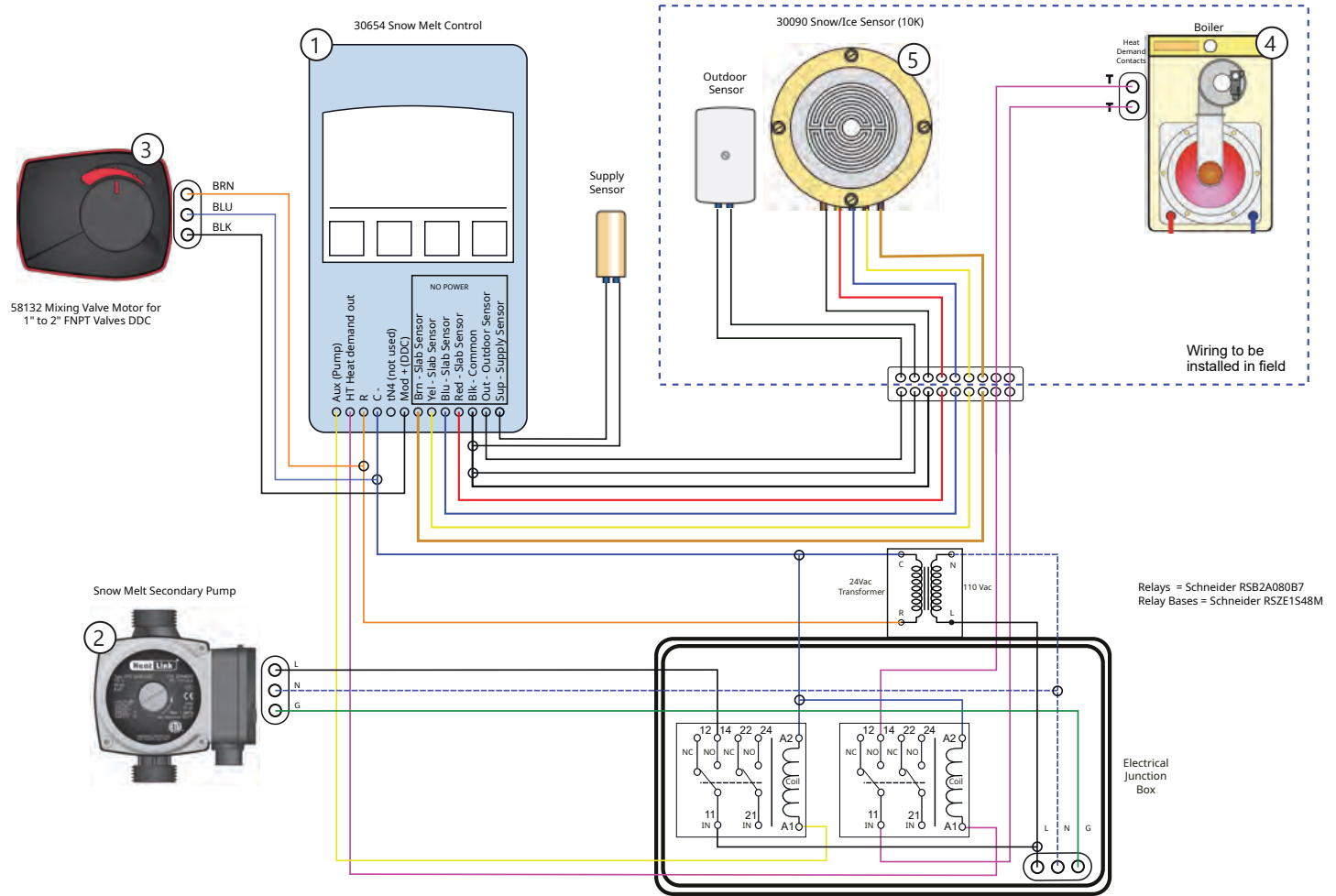

Panel Control Sequence

- 1) The 30654 Snow Melt Control (1) operates the Mixing Valve (3) and Secondary Pump (2). The heat source is hot water/glycol from a boiler (4).
- 2) The slab temperature is controlled by adjusting the mixing valve position using an analog 0 to 10V (dc) signal. The slab is heated to maintain the slab target temperature. When a Snow/Ice Sensor 30090 (5) is installed, the system automatically starts when a snow or ice is detected and continues to run until the slab is dry.
- 3) When a snow Sensor 30090 (5) is installed together with a slab sensor 30072 or 30073 the system automatically starts when snow is detected and runs on a timer before shutting off. All systems can be manually started and shut off using a timer when either a Snow/Ice Sensor 30090 or 30094 or a Slab Sensor 30072 or 30073 is installed.

Snowmelt Controls

Display

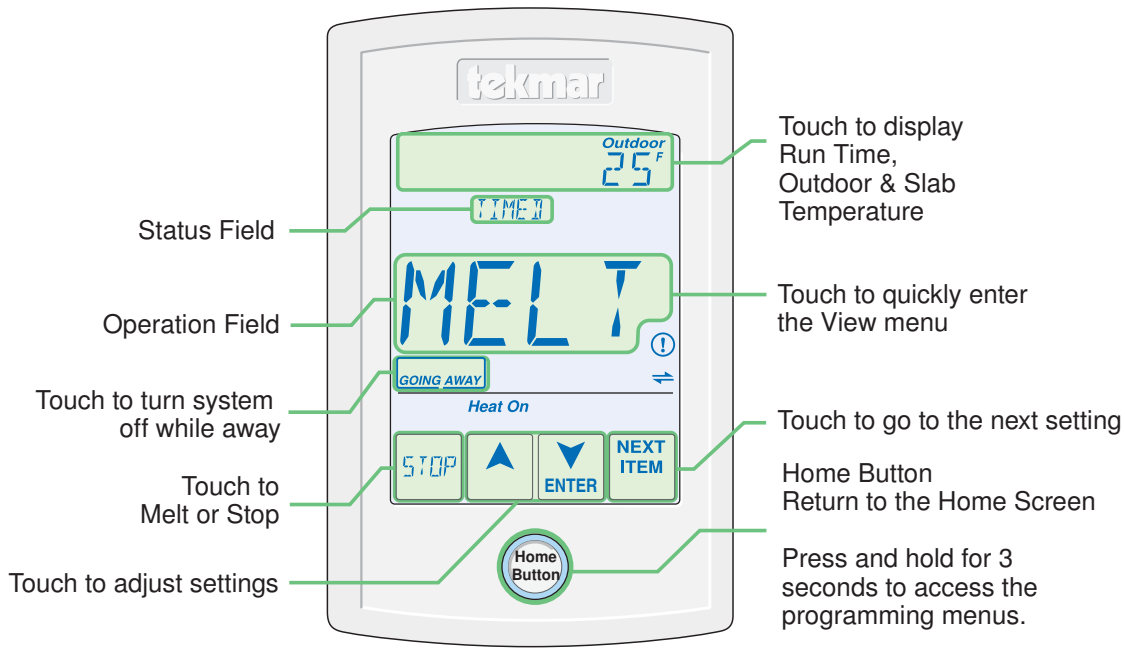

Operation Field

| | | | |
|------|--------------------------------|------|-------------------------------|
| MELT | System is melting snow or ice. | STRM | System is in storm operation. |
| IDLE | System is idling. | OFF | System is off. |

Status Field

| | | | |
|-------|--|--------|---|
| WWSD | Warm Weather Shut Down. The slab is naturally warm enough to melt snow or ice. | PEND | Pending. The system has detected water but it is too cold to operate or the schedule is in Idle or Off. |
| CWCO | Cold Weather Cut Out. Too cold to melt. | WAIT | Zone priority in effect. Zone must wait until higher priority zone finishes melting. |
| TIMED | Timed melting operation. System operates until time has elapsed. | SENSOR | Tandem 090 sensor. |
| WARM | Slab is warming up to the melting temperature. | TRACK | This zone tracks the melting operation of zone 1. |
| AWAY | Away scene. No melting until the away scene is exited. | | |

Symbols

| | | | |
|----------------|--|--|---|
| <i>Heat On</i> | HEAT ON Heat is turned on. | | WARNING SYMBOL Indicates an error is present. |
| | tekmarNet® Communication is present. | | ARROWS Adjust the displayed setting. |

Programmable Settings

Programming Menus

Press and hold the Home button for 3 seconds to enter the programming menus. The control returns to the last programming menu previously used.

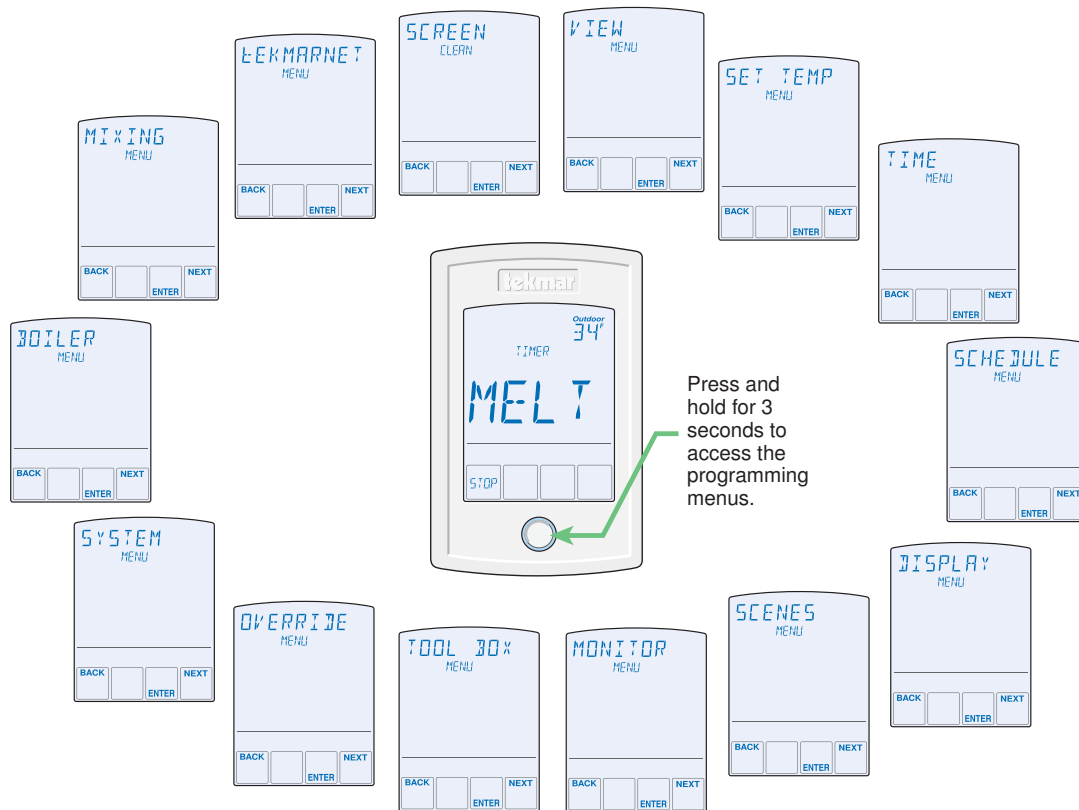

Select a Programming Menu

- Touch “NEXT” to advance (clockwise in above illustration) to the next menu.
- Touch “BACK” to go backwards (counterclockwise in above illustration) through the menus.
- Touch “ENTER” to enter a menu.

Setting Items

- Touch ▲ or ▼ arrow to adjust the setting if required.
- Touch “NEXT ITEM” to advance to the next item within the menu.
- Touch “BACK ITEM” to go backwards to the previous item within the menu.
- To return to the parent menu after changing a setting, press and release the Home button.
- To return to the Home screen, press and release the Home button twice or wait 30 seconds to automatically return to the Home screen.

Access Levels and Access Level Lock

The control is shipped pre-programmed with common settings. The control has an “Installer” access level that allows full access to all settings and a “User” access level that restricts the number of settings available. The control defaults to the “User” access level after 12 hours of operation.

Notice: tekmarNet® system controls include a Global Lock that locks all connected snow melting controls and thermostats. Set the tekmarNet® system control to unlock to allow access level adjustment on all connected devices.

To change to the “Installer” access level:

- In the Toolbox menu, locate Access
- Adjust the access level to “Installer” by pressing the up or down button. This will permit setting changes to the control.

View Menu (1 of 2)

The View menu items display the current operating temperatures and status information of the system.

| Item Field | Range | Access | Description | Set to |
|-----------------|--------------------------------------|-------------------|---|--------|
| SNOW ZONE | 1 to 12 | User Installer | SNOW ZONE The snow melt zone number on the tekmarNet® system. Conditions: tekmarNet® communication available. | |
| OUTDOOR | ---, -76 to 149°F (-60 to 65°C) | User Installer | OUTDOOR Current outdoor air temperature as measured by the local or remote outdoor sensor. The outdoor air temperature is shared to all devices in the tekmarNet® system. "---" is displayed when no outdoor sensor is available. Conditions: Application Mode is set to PWM, Boil, Mix or Elec. | |
| SLAB TARG | ---, -76 to 149°F (-60 to 65°C) | Installer | SLAB TARGET The calculated slab target of the snow melting system. "---" is displayed when the snow melt control is off. Conditions: Application Mode is set to PWM, Boil, Mix or Elec and a snow/ice sensor or slab sensor is installed. | |
| SLAB | -76 to 149°F (-60 to 65°C) | User Installer | SLAB Current slab temperature as measured by the control. Conditions: Application Mode is set to PWM, Boil, Mix or Elec and a snow/ice sensor or slab sensor is installed. | |
| SENSOR WATER | DRY or WET | User Installer | WATER SENSOR Current status of the water detection sensor. Conditions: A snow/ice sensor or snow sensor is installed. | |
| Boil TARGET | ---, 70 to 200°F (21.0 to 93.5°C) | Installer | BOILER TARGET The calculated boiler target of the snow melt system. "---" is displayed when the snow melt control is not operating the boiler. Conditions: Application Mode is set to Boil. | |
| Mix TARGET | ---, 70 to 200°F (21.0 to 93.5°C) | Installer | MIX TARGET The calculated mix target of the snow melt system. "---" is displayed when the snow melt control is not operating the mixing valve or mixing injection pump. Conditions: Application Mode is set to Mix. | |
| SUPPLY | -58 to 212°F (50.0 to 100.5°C) | Installer | SUPPLY Current system supply temperature as measured by the control. Conditions: Application Mode is set to PWM, Boil or Mix. | |
| Boil RETURN | -58 to 212°F (50.0 to 100.5°C) | Installer | BOILER RETURN Current boiler return temperature as measured by the control. Conditions: Application Mode is set to PWM, Boil or Mix and Out/Bret Sensor is set to Bret (boiler return sensor). | |
| Mix RATE | 0 to 100% | Installer | MIX RATE Current position of the mixing valve or mixing injection pump speed. Conditions: Application Mode is set to Mix. | |
| Boil RATE | 0 to 100% | Installer | BOILER RATE Current firing rate of the modulating boiler. Conditions: Application Mode is set to Boil and Boiler Type is set to Mod (modulating boiler). | |

| View Menu (2 of 2) | | | | |
|--------------------|-------------------------|-------------------|--|--------|
| Item Field | Range | Access | Description | Set to |
| HEAT RELAY | OFF or ON | User Installer | HEAT RELAY Current status of the heat relay. The boiler, pump or electric cable is on when ON is displayed. The boiler, pump or electric cable is off when OFF is displayed. Conditions: Application Mode is set to PWM, Boil, Mix, or Elec. | |
| PWM RATE | 0 to 100% | Installer | PWM RATE Current duty cycle rate of the zone or boiler for each 20 minute cycle. Conditions: Application Mode is set to PWM or Elec. Not visible when Manual Override is not Auto. | |
| SYS PUMP RELAY | OFF or ON | User Installer | SYSTEM PUMP RELAY Current status of the system pump relay. Conditions: Application Mode is set to PWM, Boil or Mix and Auxiliary Relay is set to SYS (system pump). | |
| ALERT RELAY | OFF or ON | User Installer | ALERT RELAY Current status of the alert relay. Conditions: Application Mode is set to PWM, Boil or Mix and Auxiliary Relay is set to ALRT (alert) or Application Mode is set to Elec. | |
| MAN MELT HOURS | 00:00 to 24:00 hours | User Installer | MANUAL MELT TIME When manually started, the display shows the remaining run time before shutting off. Conditions: Application Mode is set to PWM, Boil, Mix or Elec. | |
| ADD MELT HOURS | 00:00 to 6:00 hours | User Installer | ADDITIONAL MELT TIME When automatically started by a Snow/Ice Sensor 090 or 094, the display shows the remaining run time before shutting off. Conditions: Application Mode is set to PWM, Boil, Mix or Elec and a snow / ice sensor 090 or 094 is installed. | |

Display Menu

The Display menu items select the temperature units and backlight options.

| Item Field | Range | Access | Description | Set to |
|------------|--|-------------------|---|--------|
| UNITS IN | °F or °C Default = °F | User Installer | UNITS Select Fahrenheit or Celsius as the temperature units. | °C |
| BACKLIGHT | ON, ON MELT, OFF Default = ON MELT | User Installer | BACKLIGHT Select how the display backlight operates. ON = Always on. ON MELT = On when melting, off when not melting. This provides a visual indicator to occupants that the snow melting system is currently melting. OFF = Always off. | ON |

Set Temp Menu

The Set Temp menu items select the operating temperatures of the snow melt system.

| Item Field | Range | Access | Description | Set to |
|-----------------------------|--|-------------------|--|---------|
| MELTING | 32 to 95°F (0.0 to 35.0°C) Default = 36°F (2.0°C) | User Installer | MELTING Select the desired surface temperature of the snow melt surface when melting. Conditions: Application Mode is set to PWM, Boil, Mix or Elec. | 5 °C |
| IDLING | OFF, 20 to 95°F (-6.5 to 35.0°C) Default = OFF | Installer | IDLING Select the desired surface temperature of the snow melt surface when idling. Idling pre-heats the slab when the slab is dry but cold and allows faster reaction time to reach the melting temperature. Recommended for commercial use only. Conditions: Application Mode is set to PWM, Boil, Mix or Elec. | OFF |
| STORM | OFF, 20 to 95°F (-6.5 to 35.0°C) Default = 28°F (-2.0°C) | Installer | STORM Select the desired surface temperature of the snow melt surface while operating in the storm operation. Storm operation temporarily pre-heats the slab to allow faster reaction time to reach the melting temperature. Conditions: Application Mode is set to PWM, Boil, Mix or Elec. | -2.0 °C |
| MAN MELT HOURS | 0:30 to 24:00 hours Default = 4:00 hours | User Installer | MANUAL MELT RUN TIME Select the amount of running time when manually starting the system. Conditions: Application Mode is set to PWM, Boil, Mix or Elec. | 4:00 |
| ADD MELT HOURS | 0:00 to 6:00 hours Default = 0:00 hours | Installer | ADDITIONAL MELT TIME Select the amount of additional melting time after the Snow / Ice Sensor 090 or 094 is dry. This allows low spots on the slab to fully dry before the snow melting system is shut off. Conditions: Application Mode is set to PWM, Boil, Mix or Elec and a 090 or 094 Snow / Ice Sensor is installed or Track Zone is set to On. | 0:00 |
| STORM RUN HOURS | 0:30 to 24:00 hours Default = 8:00 hours | Installer | STORM RUN TIME Select the amount of storm run time to pre-heat the slab when advised of a winter storm warning. Conditions: Application Mode is set to PWM, Boil, Mix or Elec and Storm is set to a temperature. | 8:00 |
| SENSITIVITY WATER | AUTO, MIN, -2, -1, MID, +1, +2, MAX Default = AUTO | Installer | WATER SENSITIVITY Select how sensitive the Snow / Ice Sensor 090 or 094, or the Snow Sensor 095 is to water detection. Conditions: Snow / Ice Sensor is set to 090 or 095. | AUTO |
| WWSJ | AUTO, 32 to 95°F (0.0 to 35.0°C) Default = AUTO | Installer | WARM WEATHER SHUT DOWN Select the temperature at which to shut down the snow melting system during warm weather. This allows the snow or ice to melt off the slab naturally. Conditions: Application Mode is set to PWM, Boil, Mix or Elec. | AUTO |
| CWCO | OFF, -30 to 50°F (-34.5 to 10.0°C) Default = 10°F (-12.0°C) | Installer | COLD WEATHER CUT OUT Select the temperature at which to shut down the snow melting system during extremely cold weather. Below this temperature, the heat loss of the slab exceeds the capacity of the boiler or heating appliance. | OFF |

System Menu

The System Menu provides settings on how to configure and operate the mechanical equipment.

| Item Field | Range | Access | Description | Set to |
|------------------------|---|-----------|---|--------|
| APP MODE | PWM, BOIL, MIX, ELEC, 090 Default = PWM | Installer | APPLICATION MODE Select the control application mode. PWM = Hydronic Pulse Width Modulation. BOIL = Hydronic boiler heats snow melting system. MIX = Hydronic mixing valve or injection pump heats snow melting system. ELEC = Electric snow melt. 090 = Tandem Snow/ Ice Detection using 090 or 094 | MIX |
| SNOW/ICE SENSOR | NONE, 090 (or 094), 095 Default = 090 | Installer | SNOW / ICE SENSOR Select if a Snow / Ice Sensor 090 or 094, or Snow Sensor 095 is installed. | 090 |
| SLAB SENSOR | OFF or ON Default = ON | Installer | SLAB SENSOR Select if a Slab Sensor 072 or 073 is installed to measure the slab temperature. Conditions: Application Mode is set to PWM, Boil, Mix or Elec and Snow / Ice Sensor is set to None or 095. | ON |
| PROTECT SLAB | OFF or ON Default = ON | Installer | SLAB PROTECTION Select if the slab should be protected from large temperature differentials to avoid cracking the concrete due to high tensile stress. Conditions: Application Mode is set to Boil or Mix and Snow / Ice Sensor is set to 090 or Slab Sensor is set to On. | ON |
| OUT/BRET SENSOR | OFF, OUT (Outdoor) or BRET (Boiler Return) Default = OUT | Installer | OUTDOOR OR BOILER RETURN SENSOR Select if the Out/Bret wiring terminal is connected to an outdoor sensor or a boiler return sensor. Conditions: Application Mode is set to PWM, Boil or Mix or Elec. | OUT |
| ECONOMELT | OFF or ON Default = OFF | Installer | ECONOMELT EconoMelt allows the user to mechanically remove snow then manually start the system to melt the thin snow layer or ice. Conditions: Application Mode is set to PWM, Boil or Mix or Elec. | OFF |
| AUXILIARY RELAY | SYS (System Pump) or ALRT (Alert) Default = SYS | Installer | AUXILIARY RELAY Select if the auxiliary relay should function as system pump or as an alert. Conditions: Application Mode is set to PWM, Boil or Mix. | SYS |
| MAX MELT DAYS | 0.5 to 7.0 days, OFF Default = 3.0 days | Installer | MAXIMUM MELT TIME Select to limit the amount of melting run time after snow is automatically detected by a Snow / Ice Sensor 090 or 094, or a Snow Sensor 095. Conditions: Application Mode is set to PWM, Boil or Mix or Elec. | 3.0 |

Boiler Menu

The Boiler Menu provides settings on how to configure and operate the boiler.

| Item Field | Range | Access | Description | Set to |
|------------------|---|-----------|---|--------|
| Boil TYPE | <p><i>App Mode = Boil</i> MOD, 1STG, EMS1, EMS2 Default = MOD</p> <p><i>App Mode = Mix</i> OFF, ENBL, CTRL Default = OFF</p> <p><i>App Mode = PWM</i> OFF, CTRL Default = OFF</p> | Installer | <p>BOILER TYPE The type of boiler connected to the control. MOD = Modulating boiler. 1STG = Single one-stage on-off boiler. EMS1 = tekmar boiler staging controls. EMS2 = Viessmann modulating boilers with 0-10 V OpenTherm Module. CTRL = tekmarNet® System Control operates boiler. The control must be connected to tekmarNet® to support this option. ENBL = When operating a mixing valve or mixing injection pump, the heat relay is closed to fire the boiler.</p> | ENBL |

Mix Menu









The Mix Menu provides settings on how to configure and operate the mixing valve or mixing injection pump. The Mix menu is only available when the Application Mode is set to Mix.

| Item Field | Range | Access | Description | Set to |
|-------------------------|--|-----------|---|--------|
| Mix TYPE | 0-10 or 4-20 Default = 0-10 | Installer | <p>MIX TYPE Select the type of mixing analog signal. 0-10 = 0 to 10 V (dc) 4-20 = 4 to 20 mA</p> | 0-10 |
| MOTOR SPD SEC | 30 to 230 seconds Default = 105 seconds | Installer | <p>MIX MOTOR SPEED The time that the mix actuating motor requires to operate from fully closed to fully open. Mixing Injection Pump = 30 seconds tekmar Actuator Motor 742 = 105 seconds Refer to actuating motor for correct setting.</p> | 120 |
| Mix MAX | 80 to 180°F (26.5°C to 82.0°C), OFF Default = 140°F (60°C) | Installer | <p>MIX MAXIMUM Select the maximum operating temperature of the system supply water.</p> | 60 °C |

Troubleshooting - Error Messages

It is recommended to complete all wiring to ensure trouble free operation. Should an error occur, simply follow these steps:

- Find:** If the control flashes  on the screen, it is indicating a problem on the system.
- Identify:** Hold the Home button for 3 seconds, touch the NEXT key to locate the Toolbox Menu, then touch the ENTER key. The error code should appear as the first item.
- Solve:** Use the chart below to match the error code to the one on the control. Use the description to solve the problem.

| Error Messages (1 of 4) | |
|---|--|
| Error Message | Description |
|  | <p>SET TEMP MENU SAVE ERROR The control failed to read the Set Temp menu settings from memory and has reloaded the factory default settings. The control stops operation until all settings in the Set Temp menu are checked. To clear the error, set the access level to Installer and check all settings in the Set Temp menu.</p> |
|  | <p>SYSTEM MENU SAVE ERROR The control failed to read the System menu settings from memory and has reloaded the factory default settings. The control stops operation until all settings in the System menu are checked. To clear the error, set the access level to Installer and check all settings in the System menu.</p> |
|  | <p>BOILER MENU SAVE ERROR The control failed to read the Boiler menu settings from memory and has reloaded the factory default settings. The control stops operation until all settings in the Boiler menu are checked. To clear the error, set the access level to Installer and check all settings in the Boiler menu.</p> |
|  | <p>MIXING MENU SAVE ERROR The control failed to read the Mixing menu settings from memory and has reloaded the factory default settings. The control stops operation until all settings in the Mixing menu are checked. To clear the error, set the access level to Installer and check all settings in the Mixing menu.</p> |
|  | <p>tekmarNet® MENU SAVE ERROR The control failed to read the tekmarNet® menu settings from memory and has reloaded the factory default settings. The control continues to operate but does not provide any tekmarNet® features until all settings in the tekmarNet® menu are checked. To clear the error, set the access level to Installer and check all settings in the tekmarNet® menu.</p> |
|  | <p>SCHEDULE MENU SAVE ERROR The control failed to read the Schedule menu settings from memory and has reloaded the factory default settings. The control operates with the programmable schedule disabled until all settings in the Schedule menu are checked. To clear the error, set the access level to Installer and check all settings in the Schedule menu.</p> |
|  | <p>SCENES MENU SAVE ERROR The control failed to read the Scenes menu settings from memory and has reloaded the factory default settings. The control operates with the away scene disabled until all settings in the Scenes menu are checked. To clear the error, set the access level to Installer and check all settings in the Scenes menu.</p> |
|  | <p>MAXIMUM MELT TIME ERROR The control has operated in melting for the time set by Maximum Melt Days setting located in the System menu. This error is usually created when there is a mechanical system failure resulting in the snow melt slab not heating correctly. Clear the error message by touching the Cancel key while viewing the error message. Use the Manual Override menu to manually check that each component of the mechanical system is operating correctly. If necessary, change the Maximum Melt Days setting to a longer time period or to Off.</p> |
|  | <p>tekmarNet® COMMUNICATION ERROR The tekmarNet® communication bus has either an open or a short circuit. The result is that there are no communications. Check for loose wires between tN4 and C. Check for short circuits between the tN4 and C wires on the House Control, Wiring Center, or Zone Manager. Check for correct polarity between the C and R wires. The error clears automatically once the wiring fault has been corrected. To force the error to clear while allowing a short or open circuit to continue, touch the Cancel key.</p> |

Error Messages (2 of 4)

| Error Message | Description |
|--|--|
| <p>ADDRESS TAKEN ERR</p> | <p>ADDRESS TAKEN ERROR Two devices (thermostats, setpoint controls, snow melting controls) have been manually set to the same address. The device continues to operate with this error but does not communicate with the tekmarNet® system. To clear this error, select an unused tekmarNet® address or select automatic addressing.</p> |
| <p>SNOW ZONE TAKEN ERR</p> | <p>SNOW ZONE TAKEN ERROR Two snow melting controls have been manually set to the same snow zone number and one of the controls is NOT set to App Mode 090. The control continues to operate with this error. To clear this error, select an unused snow zone number or set the App Mode to 090. Once the error has been corrected, press the "Cancel" key to clear the error message.</p> |
| <p>APP MODE 090 ERR</p> | <p>APP MODE 090 ERROR Two snow melting controls have been manually set to the same snow zone number and both of the controls are set to App Mode 090. To clear this error, select an unused snow zone number or set the App Mode to anything other than 090.</p> |
| <p>TANDEM 090 ERR</p> | <p>TANDEM 090 ERROR There are two Snow / Ice Sensors 090 or 094 installed in the zone and the other snow melting control's 090 or 094 has a sensor problem. Locate the other snow melting control and navigate to the Toolbox menu to determine and correct the problem. The control continues to operate with this error.</p> |
| <p>DEVICE LIMIT ERR</p> | <p>DEVICE LIMIT More than 24 devices (thermostats or setpoint controls) have been connected to the tekmarNet® communication bus. To clear the error, remove and relocate devices to other available buses until the device count is 24 or less.</p> |
| <p>OUTDOOR SHORT ERR</p> | <p>OUTDOOR SENSOR SHORT CIRCUIT ERROR Due to a short circuit, the control is unable to read the Outdoor Sensor 070. The control continues to operate and assumes an outdoor temperature of 32°F (0°C). Energy saving features such as Warm Weather Shut Down (WWSD) and Cold Weather Cut Out (CWCO) are disabled. Check the outdoor sensor wire for short circuits according to the sensor installation manual. It may be necessary to replace the outdoor sensor. Once the error has been corrected, the error message automatically clears.</p> |
| <p>OUTDOOR OPEN ERR</p> | <p>OUTDOOR SENSOR OPEN CIRCUIT ERROR Due to an open circuit, the control is unable to read the Outdoor Sensor 070. The control continues to operate and assumes an outdoor temperature of 32°F (0°C). Energy saving features such as Warm Weather Shut Down (WWSD) and Cold Weather Cut Out (CWCO) are disabled. Check the outdoor sensor wire for open circuits according to the sensor installation manual. It may be necessary to replace the outdoor sensor. Once the error has been corrected, the error message automatically clears.</p> |
| <p>SUPPLY SHORT ERR</p> | <p>SUPPLY SENSOR SHORT CIRCUIT ERROR Due to a short circuit, the control is unable to read the Supply Sensor 082. When set to App Mode Boiler or Mixing the control stops operation and does not provide any heat. Check the supply sensor wire for short circuits according to the sensor installation manual. It may be necessary to replace the supply sensor. Once the error has been corrected, the error message automatically clears.</p> |
| <p>SUPPLY OPEN ERR</p> | <p>SUPPLY SENSOR OPEN CIRCUIT ERROR Due to an open circuit, the control is unable to read the Supply Sensor 082. When set to App Mode Boiler or Mixing the control stops operation and does not provide any heat. Check the supply sensor wire for open circuits according to the sensor installation manual. It may be necessary to replace the supply sensor. Once the error has been corrected, the error message automatically clears.</p> |
| <p>BOILER RETURN SHORT ERR</p> | <p>BOILER RETURN SENSOR SHORT CIRCUIT ERROR Due to a short circuit, the control is unable to read the Boiler Return Sensor 082. The control continues operation but does not provide any boiler return protection. Check the boiler return sensor wire for short circuits according to the sensor installation manual. It may be necessary to replace the boiler return sensor. Once the error has been corrected, the error message automatically clears.</p> |

Error Messages (3 of 4)

| Error Message | Description |
|---------------------------------------|---|
| BOILER RETURN OPEN ERR | BOILER RETURN SENSOR OPEN CIRCUIT ERROR Due to an open circuit, the control is unable to read the Boiler Return Sensor 082. The control continues operation but does not provide any boiler return protection. Check the boiler return sensor wire for open circuits according to the sensor installation manual. It may be necessary to replace the boiler return sensor. Once the error has been corrected, the error message automatically clears. |
| SLAB SHORT ERR | SLAB SENSOR SHORT CIRCUIT ERROR Due to a short circuit, the control is unable to read the Slab Sensor 072 or 073. Idling and Storm are disabled and energy saving features such as Warm Weather Shut Down (WWSD) and Cold Weather Cut Out (CWCO) are operate using the outdoor temperature only. Check the slab sensor wire for short circuits according to the sensor installation manual. It may be necessary to replace the slab sensor. Once the error has been corrected, the error message automatically clears. |
| SLAB OPEN ERR | SLAB SENSOR OPEN CIRCUIT ERROR Due to an open circuit, the control is unable to read the Slab Sensor 072 or 073. Idling and Storm are disabled and energy saving features such as Warm Weather Shut Down (WWSD) and Cold Weather Cut Out (CWCO) are operate using the outdoor temperature only. Check the slab sensor wire for open circuits according to the sensor installation manual. It may be necessary to replace the slab sensor. Once the error has been corrected, the error message automatically clears. If the slab sensor has been intentionally removed, set the slab sensor setting in the System menu to Off. |
| YELLOW OPEN ERR | YELLOW WIRE OPEN CIRCUIT ERROR Due to an open circuit, the control is unable to read the yellow wire connected to the Snow / Ice Sensor 090 or 094, or the Snow Sensor 095. The control can no longer automatically detect snow or ice but manual start of the snow melting system is still available. Check the Snow / Ice Sensor or Snow Sensor yellow and black wires and any wire splices for open circuits according to the sensor installation manual. It may be necessary to replace the sensor. Once the error has been corrected, the error message automatically clears. |
| BLUE SHORT ERR | BLUE WIRE SHORT CIRCUIT ERROR Due to a short circuit, the control is unable to read the blue wire connected to the Snow / Ice Sensor 090 or 094, or the Snow Sensor 095. The control can no longer automatically detect snow or ice but manual start of the snow melting system is still available. First check the Snow / Ice Sensor or Snow Sensor for dirt or debris. The ring structure of the sensor may need cleaning with hot soapy water and a nylon brush. Rinse with water. Secondly, check the Snow / Ice Sensor or Snow Sensor blue and black wires and any wire splices for short circuits according to the sensor installation manual. It may be necessary to replace the sensor. Once the error has been corrected, the error message automatically clears. |
| BLUE OPEN ERR | BLUE WIRE OPEN CIRCUIT ERROR Due to an open circuit, the control is unable to read the blue wire connected to the Snow / Ice Sensor 090 or 094, or the Snow Sensor 095. The control can no longer automatically detect snow or ice but manual start of the snow melting system is still available. Check the Snow / Ice Sensor or Snow Sensor blue and black wires and any wire splices for open circuits according to the sensor installation manual. It may be necessary to replace the sensor. Once the error has been corrected, the error message automatically clears. |
| BROWN OPEN ERR | BROWN WIRE SENSOR OPEN CIRCUIT ERROR Due to an open circuit, the control is unable to read the brown wire connected to the Snow / Ice Sensor 090 or 094. Idling and Storm is disabled and energy saving features such as Warm Weather Shut Down (WWSD) and Cold Weather Cut Out (CWCO) are operate using the outdoor temperature only. Check the Snow / Ice Sensor brown and black wires for open circuits according to the sensor installation manual. It may be necessary to replace the sensor. Once the error has been corrected, the error message automatically clears. |
| SNOW / ICE SENSOR ERR | SNOW / ICE SENSOR ERROR The control is unable to properly detect the Snow / Ice Sensor 090 or 094. The control can no longer automatically detect snow or ice but manual start of the snow melting system is still available. Check the Snow / Ice Sensor brown, yellow, red and black wires according to the sensor installation manual. It is important to check any cable splices for loose wiring connections. It may be necessary to replace the sensor. Once the error has been corrected, the error message automatically clears. |

Error Messages (4 of 4)

| Error Message | Description |
|-------------------------------------|---|
| <p>SNOW SENSOR ERR</p> | <p>SNOW SENSOR ERROR The control is unable to properly detect the Snow Sensor 095. The control can no longer automatically detect snow but manual start of the snow melting system is still available. Check the Snow Sensor yellow, red and black wires according to the sensor installation manual. It may be necessary to replace the sensor. Once the error has been corrected, the error message automatically clears.</p> |
| <p>SCHEDULE MASTER ERR</p> | <p>SCHEDULE MASTER ERROR Two devices on the tekmarNet® system have been set to the same Schedule Master number. The control operates according to the local programmable schedule while this error is present. To clear the error, select a different Schedule Master number, set a different Schedule Member number, set the Schedule to Zone, or set the Schedule to None.</p> |
| <p>SCHEDULE MEMBER ERR</p> | <p>SCHEDULE MEMBER ERROR The control can no longer detect its schedule master. The control operates as if the programmable schedule is in idle or off operation while this error is present. To clear the error, select a different Schedule Member number, set the Schedule to Zone, or set the Schedule to None.</p> |
| <p>ERROR AT TSTAT 01</p> | <p>ERROR AT THERMOSTAT There is an error on a different thermostat or setpoint control connected to the tekmarNet® system and not on this control. 01 to 24 = There is an error on a thermostat or setpoint control with this tekmarNet® address.</p> |
| <p>ERROR AT TSTAT b:01</p> | <p>ERROR AT THERMOSTAT There is an error on a different thermostat or setpoint control connected to the tekmarNet® system and not on this control. b:01 to b:24 = There is an error on a thermostat or setpoint control wired to the boiler communication bus with this tekmarNet® address.</p> |
| <p>ERROR AT TSTAT 1:01</p> | <p>ERROR AT THERMOSTAT There is an error on a different thermostat or setpoint control connected to the tekmarNet® system and not on this control. 1:01 to 1:24 = There is an error on a thermostat or setpoint control wired to communication bus 1 with this tekmarNet® address.</p> |
| <p>ERROR AT TSTAT 2:01</p> | <p>ERROR AT THERMOSTAT There is an error on a different thermostat or setpoint control connected to the tekmarNet® system and not on this control. 2:01 to 2:24 = There is an error on a thermostat or setpoint control wired to communication bus 2 with this tekmarNet® address.</p> |
| <p>ERROR AT TSTAT 3:01</p> | <p>ERROR AT THERMOSTAT There is an error on a different thermostat or setpoint control connected to the tekmarNet® system and not on this control. 3:01 to 3:24 = There is an error on a thermostat or setpoint control wired to the mix 3 bus with this tekmarNet® address.</p> |
| <p>ERROR AT SYSTEM CTRL</p> | <p>ERROR AT SYSTEM CONTROL There is an error on the tekmarNet® system control connected to the tekmarNet® system and not on this control.</p> |
| <p>INTERNAL FAULT</p> | <p>INTERNAL FAULT To determine and clear the error, go to the Toolbox menu 1. Hold the Home button for 3 seconds 2. Press Next Item until Toolbox Menu is found 3. Press Enter There are four conditions that will generate an "Internal Fault" message: Max Melt Days Error, System Save Error, Boiler Save Error or Mixing Save Error Go to the respective error message in this manual to correct the error condition</p> |

Troubleshooting

| Problem | Check / Verify | Possible Cause |
|---------------------------------------|---------------------------------|---|
| LCD Display is Off | Control has power | Use electrical meter to measure 24V (ac) voltage on input power R and C terminals. |
| System pump is always on | Display shows idle | Idle operation requires that the system pump operate continuously while below the melting temperature setting. |
| Blue short | Dirt or salt on snow/ice sensor | The snow/ice sensor requires regular cleaning. Avoid using road salt on the snow melting slab. |
| Slab is above melt temperature | Slab target temperature | The slab is heated to the slab target temperature. |
| | Heat On not shown | Check wiring of the system pump. Yje system pump operates continuously during melt, idle or storm operation. The heat source must be wired to operate together with the heat relay. |
| System running with no snow | Idle | Idling heats the slab when the temperature falls below the Idle temperature. |
| | Melt | During Cold Weather Cut Out (CWCO), the system is shut off. If shut off during a melt cycle, the system resumes melting once the outdoor temperature is above CWCO. |
| | Timed Melt | System manually started. |
| | Scheduled Melt | System started on a programmable schedule. |
| Snow on slab but system did not start | Off | System has a programmable schedule and is in event 2 or 4 (unoccupied). |
| | Off | System has been manually stopped and the automatic snow/ice sensor never dried, thereby preventing the system from automatically starting. |



www.heatlink.com

September 22, 2023

Printed in Canada

©HeatLink Group Inc.