

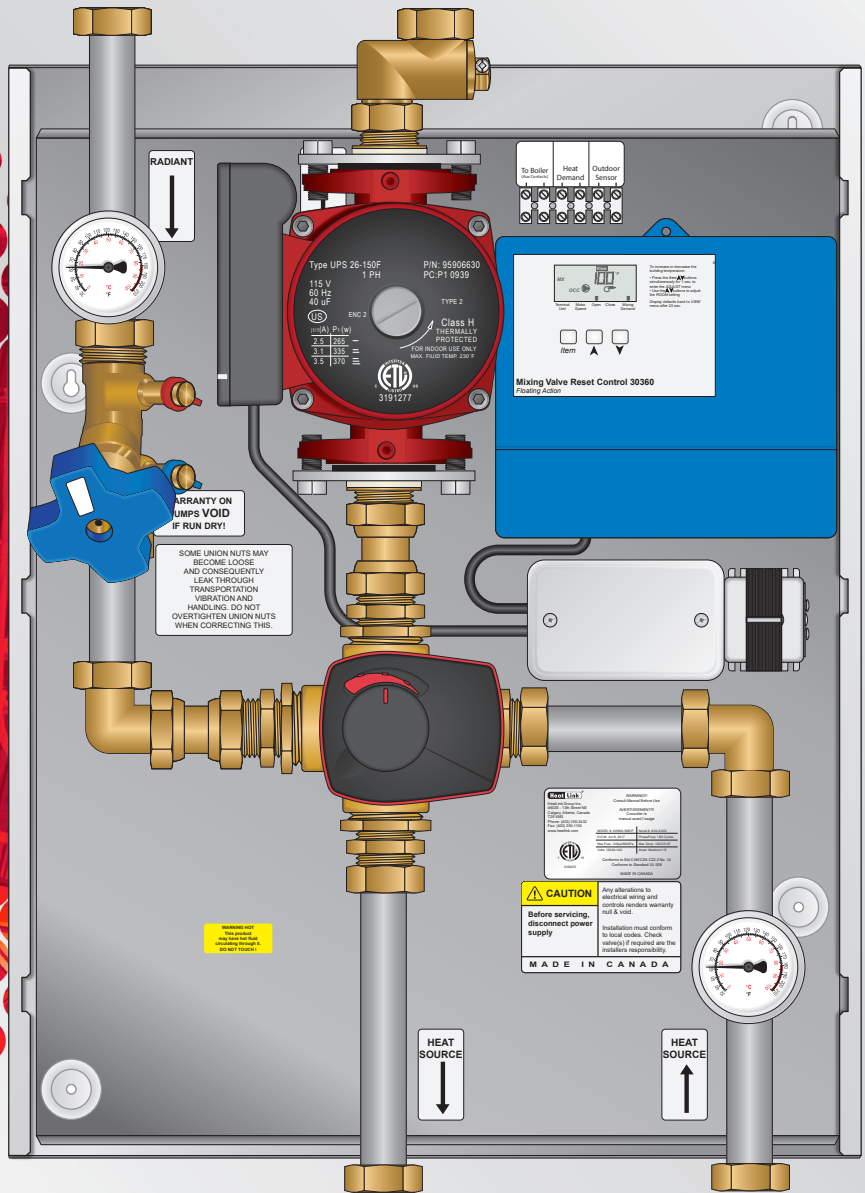

# Panel Model

## Installation, Operation, and Maintenance Manual



Product Safety Information.....	2
Warnings.....	2
Servicing.....	2
Function.....	2
Unpacking.....	3
Installation Tools Needed.....	3
Panel Components.....	4
Panel Components (cont'd).....	5
Specifications & Listings.....	5
Technical Data - UPS 26-99 FC.....	6
Technical Data - UPS 26-150 FC.....	7
Panel Mounting.....	9
Piping Hookup.....	10
Fill & Purge.....	11
Piping Options.....	12
Panel Wiring.....	13
Wiring Diagram.....	13
Panel Control Sequence.....	14
Reset Control Overview.....	15
User Interface.....	15
Display.....	15
Symbol Description.....	16
General Operation.....	16
Mixing.....	17
Boiler Operation.....	18
Boiler Sensor Placement.....	18
Setup.....	19
DIP Switch Settings.....	19
Quick Setup.....	20
Troubleshooting.....	25

## Disclaimer

HeatLink Group Inc. shall not be responsible for errors in its brochures or printed materials. HeatLink Group Inc. reserves the right to alter its products at any time without notice, provided that alterations to products already on order shall not require material changes in specifications previously agreed upon HeatLink Group Inc. and the Purchaser. All trademarks in this material are property of the respective companies. HeatLink and the HeatLink logotype are trademarks of HeatLink Group Inc. All rights reserved.

## Product Safety Information

### Warnings

The zone control panel is for indoor use only and must be installed by a qualified installer/service technician. This product must be installed and operated in strict accordance with the terms set out in this manual and in accordance with the relevant requirements of the Local Authority Having Jurisdiction. Failure to comply will result in a void of warranty, and may also result in property damage, serious injury, or death.

### Servicing

Prior to commencing installation of this panel it is necessary to read and understand all sections of this manual. The symbols below are used throughout this document to ensure proper operation of the panel, and your safety. Please pay attention to these symbols.



**Warning**  
Possible Hazard



**Warning**  
Live Power



**Warning**  
Hot Pipes



**Warning**  
Treated Water



In order to avoid injury or death, switch off the power to the panel prior to inspecting or making connections to the terminal strip.

### Function

This zone control panel can provide mixing, distribution, and zoning for a wide variety of hydronic heating applications.

The effectiveness of the system is dependant on the system being designed and installed correctly. Proper consideration of factors such as BTU loads, outdoor design temperature, indoor design temperature, room set-point temperature(s), differential fluid temperatures, head loss, flow rates, and transfer capacities of the heat emitters is critical.

Once these factors have been considered and the system requirements determined, these can then be evaluated and compared to the panel capabilities.

## Unpacking

- Step 1** Examine carton for any damage that may have occurred during shipping. If damage is visible notify your courier and supplier immediately.
- Step 2** Open the carton by removing the staples.
- Step 3** Remove the cardboard spacers from the carton, then remove the panel from the carton. Lift the panel by the base, not the enclosure.
- Step 4** There are 2 screws holding the enclosure in place during shipping. They are located at the top left & right of the panel base. Remove these 2 screws.
- Step 5** Remove the enclosure from the panel by sliding it upwards until it stops, then gently pulling outwards off.

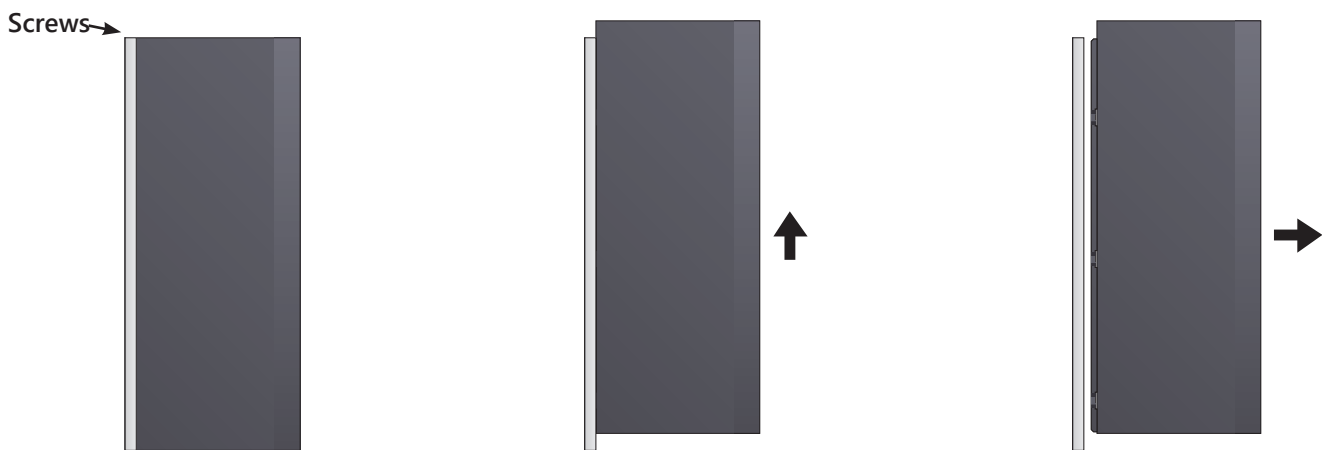

## Installation Tools Needed

- Level
- Screwdriver or power drill
- Flat head bit
- Phillips head bit # 2
- 2 adjustable wrenches (or 2 × 30mm wrenches)

Panel Components

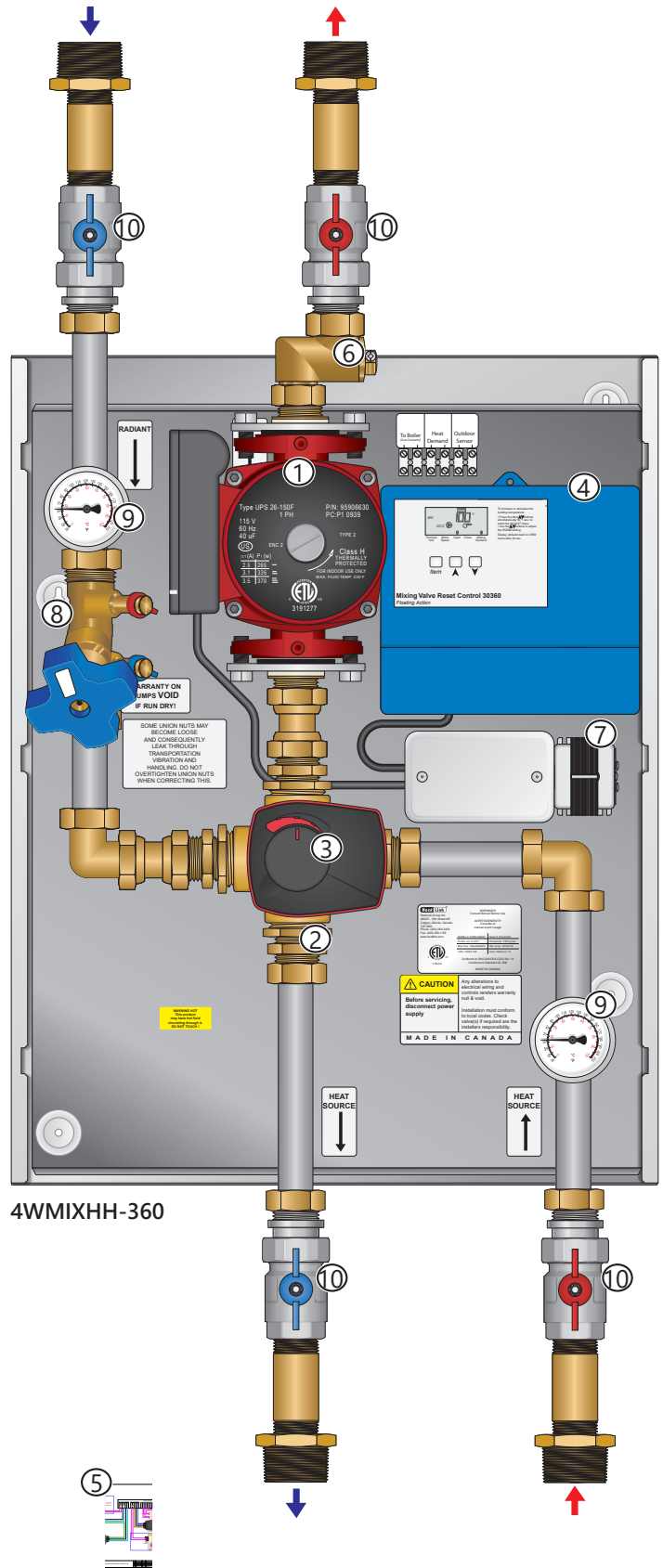
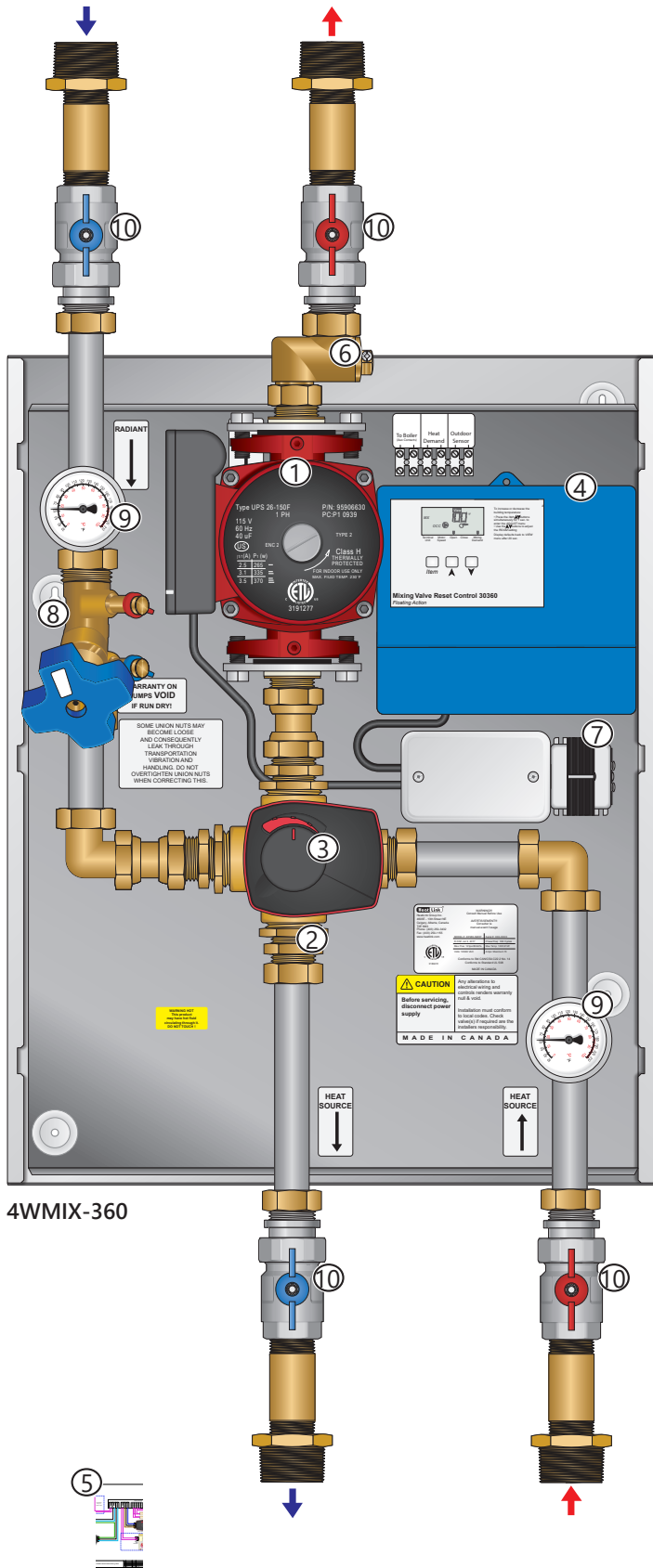

## Panel Components (cont'd)

#	Components	Part Number	
		4WMIX-360	4WMIXHH-360
1	Secondary pump	UPS26-99	UPS26-150
2	1¼" Mixing valve (hidden)		64031
3	Mixing valve motor		58132
4	Mixing Reset Control		30360
5	Outdoor Sensor		30070
6	Supply sensor		ETF1899ASNS
7	24V(ac) transformer		n/a
8	Balancing valve		n/a
9	Thermometer		n/a
10	Isolation valve assemblies*		n/a

\*Packaged in accessory box for shipping. See page 10 for piping hookup instructions.

## Specifications &amp; Listings

	4WMIX-360	4WMIXHH-360
Listing		cETLus
Conforms to		CAN/CSA-C22 No.14, UL508
Dimensions		24"H × 18¾"W × 8"D
Weight		
Max ambient temperature		120°F
Max water temperature		200°F
Settable fluid temperature range		100-145°F
Power supply	120V(ac)	
Circulator	Ferrous, Grundfos UPS26-99FC	Ferrous, Grundfos UPS26-150FC
Auxiliary terminal		none
Temperature control method		1¼" 4-Way Mixing Valve w/ 3-point floating point motor
Temperature control range		50-180°F (10-82°C)
Mixing valve Cv		18.7
Piping		1" 304 stainless steel tubing, 1" brass
Piping connections		1½" MNPT
Backplate		Galvanized steel
Enclosure		Powder coated steel

### Panel Component Specifications

#### Circulator

The circulator moves the heated fluid through the system when there is a call for heat from the system controller.

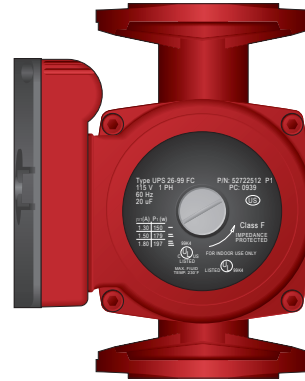

The addition of glycol to the system will result in higher demand from the circulator due to the change in viscosity of the fluid.

#### Technical Data - UPS 26-99 FC

Material:

- Inlet cone, bearing plate, bearing retainers, rotor can, rotor cladding, shaft retainer:..... Stainless Steel
- Stator Housing:..... Aluminium
- Shaft, upper and lower radial bearings:..... Aluminium oxide ceramic
- Thrust bearing: ..... Carbon bearing and EPDM retainer
- Check valve:..... ACETAL with 302 SS spring and nitrile rubber seats
- Pump housing (volute):..... Cast iron
- O-ring and gaskets:..... EPDM
- Impeller:..... PES composite (30% glass-filled)
- Terminal box:..... Noryl® with EPDM gasket
- Flow Range:..... 0-33 US gpm (0-7.5 m³/h)
- Head Range:..... 0-29 ft (0-8.8 m)
- Motors:..... 2-pole, single-phase
- Max. Liquid Temperature:..... 230°F (110°C)
- Min. Liquid Temperature:..... 36°F (2°C)
- Max. System Pressure:..... 145 psi (10 bar)

Speed	Volts	Amps	Watts	Hp	Capacitor
3	115	1.8	197	1/6	20 µF/180V
2		1.5	179	1/6	
1		1.3	150	1/6	

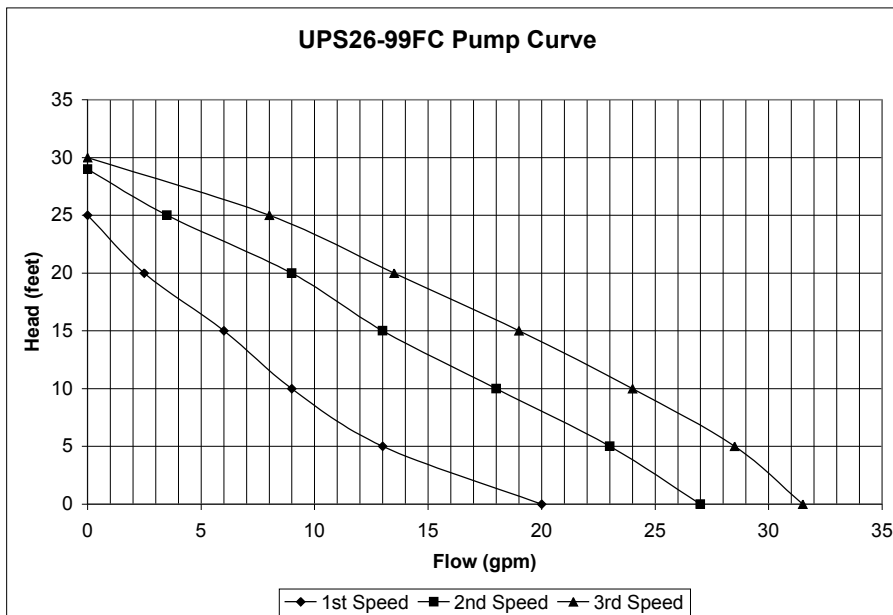

**Technical Data - UPS 26-150 FC**

Material:

- Inlet cone, bearing plate, bearing retainers, rotor can, rotor cladding, shaft retainer:..... Stainless Steel
- Stator Housing:..... Aluminium
- Shaft, upper and lower radial bearings:..... Aluminium oxide ceramic
- Thrust bearing: ..... Carbon bearing and EPDM retainer
- Check valve:..... ACETAL with 302 SS spring and nitrile rubber seats
- Pump housing (volute):..... Cast iron
- O-ring and gaskets:..... EPDM
- Impeller: ..... PES composite (30% glass-filled)
- Terminal box:..... Noryl® with EPDM gasket
- Flow Range:..... 0-53 US gpm (0-12 m<sup>3</sup>/h)
- Head Range:..... 0-46 ft (0-14 m)
- Motors:..... 2-pole, single-phase
- Max. Liquid Temperature:..... 230°F (110°C)
- Min. Liquid Temperature:..... 36°F (2°C)
- Max. System Pressure:..... 145 psi (10 bar)

Speed	Volts	Amps	Watts	Hp	Capacitor
3	115	3.5	370	1/6	40 µF/180V
2		3.1	335	1/6	
1		2.5	265	1/6	

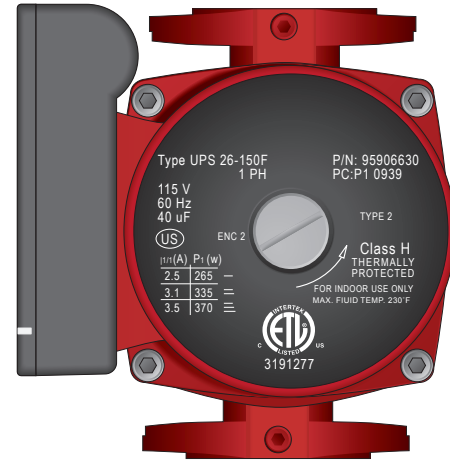

**UPS 26-150 Pump Curve**

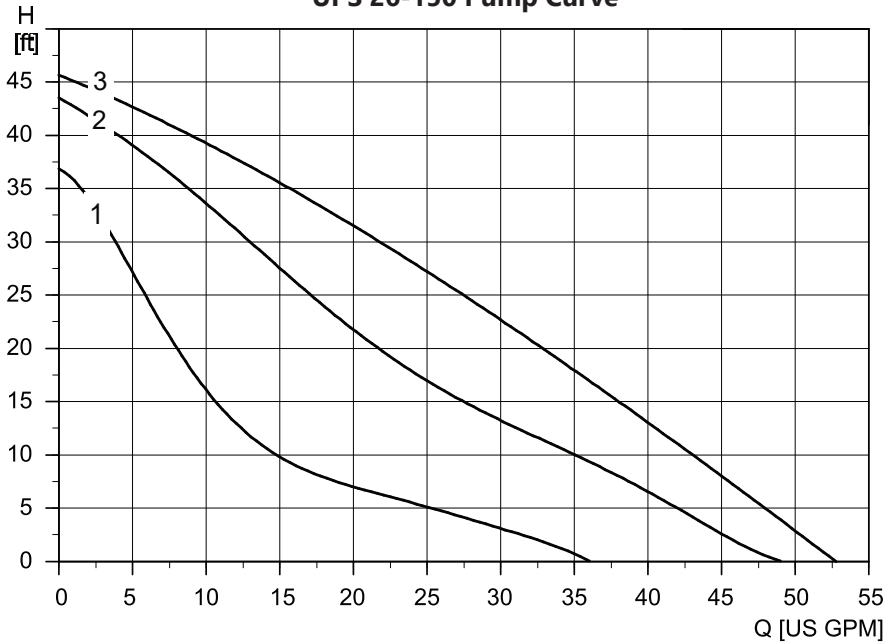



### Control Valve

4-way brass mixing valve regulates the temperature in the hydronic system with the help of the electric motor actuator and system controller.

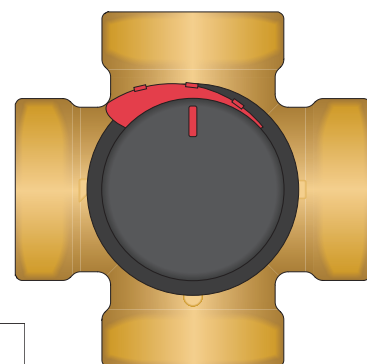

#### Technical Data - 4-way mixing valve

Material - Valve Body & Slide:	Brass DZR
Material - Shaft & Bushing:	PPS composite
Material - O-ring:	EPDM
Max. Operating Temperature:	230°F (110°C)
Min. Operating Temperature:	-15°F (-10°C)
Max. Operating Pressure:	145 psi (10 bar)
Max. Differential Pressure:	14.5 psi (1 bar)
Leaking in % of flow*:	<1.0%
Max. Torque:	<44lbf*in (<5Nm)

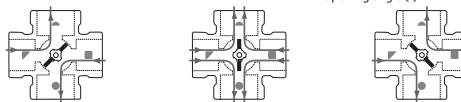
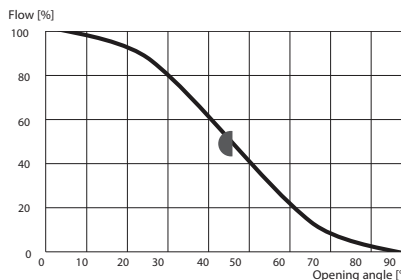

\*based on diff. pressure of 14.5 psi (1 bar)

### Mixing Valve Motor

The mixing valve motor is mounted to the control valve and moves the valve appropriately to allow the heated fluid to enter. This motor works in conjunction with the system controller.



#### Manual Operation of Mixing Valve Motor

NOTE: Mixing Valve Motor should not be placed in manual mode for an extended period of time.

- Pull knob out on motorized actuator.
- Rotate knob clockwise or counter-clockwise.
- To return to automatic mode, push the knob in.

#### Technical Data - 3 Point Floating Mixing Valve Motor

Ambient Temperature:	max. 131°F (55°C)
	min. 23°F (-5°C)
Power Supply:	24 ± 10% VAC 50 Hz
	230 ± 10% VAC 50 Hz
Enclosure Rating:	IP41
Protection Class:	II
Torque:	6 Nm
Power Consumption - Dimensioning:	24V: 3 VA
	230V: 5 VA
Rating Auxiliary Switch:	6(3)A 250VAC
Running Time 90°:	45/120 sec

The motor should be preceded by a multi-pole contact breaker in the fixed installation.

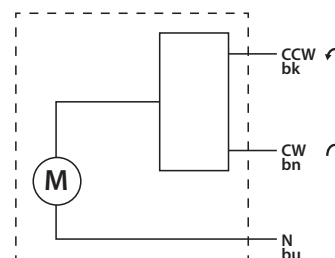

CE LVD 2006/95/EC  
EMC 2004/108/EC  
RoHS 2011/65/EC

## Panel Mounting

Prior to mounting the panel, ensure the wall is capable of supporting the weight of the panel, and that all required power outlets and/or wiring is available at the installation location.

- Step 1** Determine the location and distance between the wall studs. With a level at a minimum height of 4' from the floor, draw a straight line and mark the stud locations. If the panel cannot be secured directly to the studs, or suitable backing boards, plywood may need to be installed behind the panel to properly secure it in place.
- Step 2** Screw two of the supplied mounting screws into the wall studs (or backing plywood) 3/4" and 6 1/2" from the top of the desired height, and 16" apart, leaving 1/4" of the screw out from the wall.
- Step 3** Lift and place the panel onto the mounting screws. Two person lift may be required.
- Step 4** Screw the remaining mounting screws into the holes at the bottom of the panel, and tighten the top two screws.

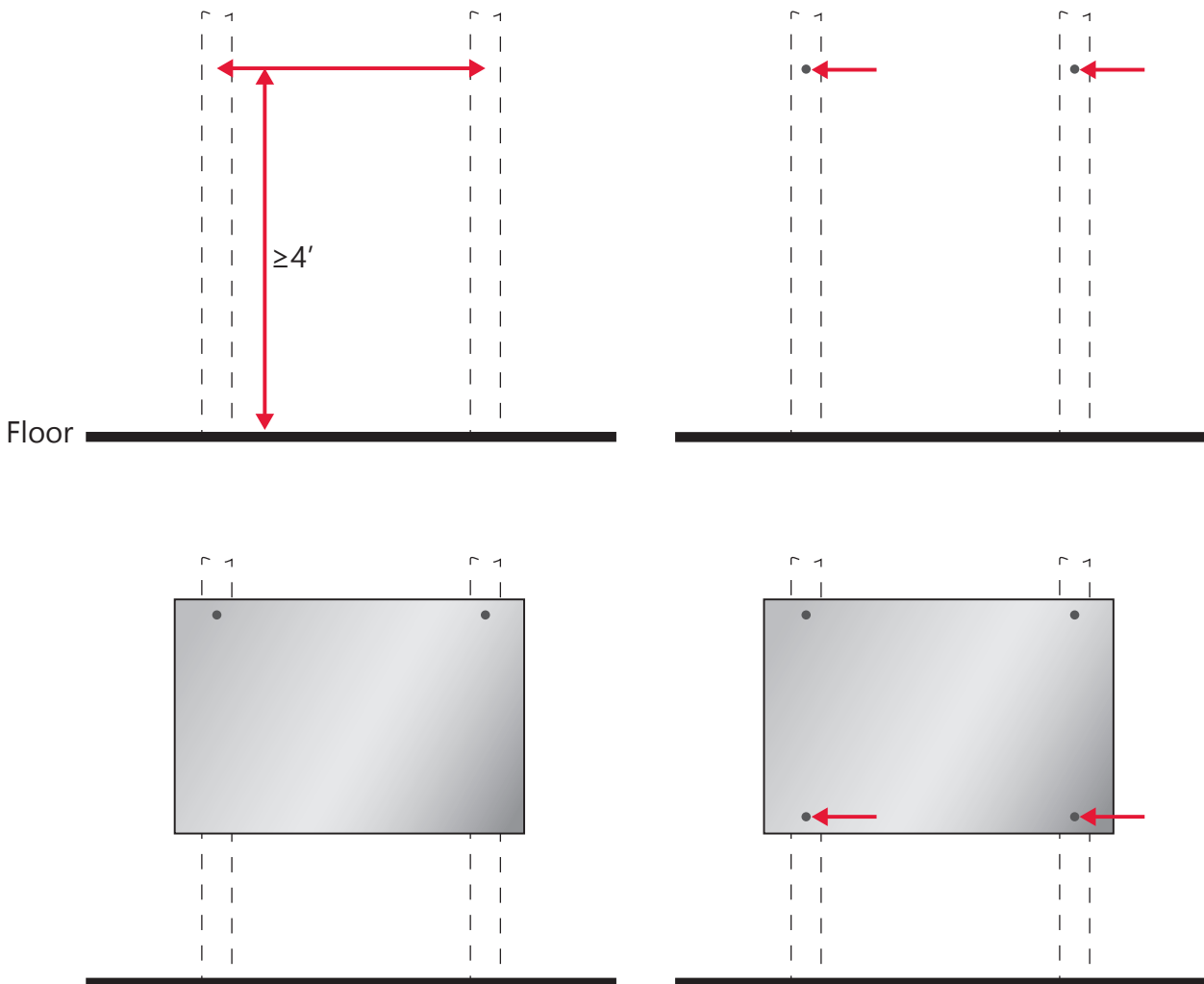

### Piping Hookup

The 4WMIX-360 ships with the adapter assemblies packaged in the accessory pack, and must be connected to the panel *after* the system connections have been made.

- Step 1** Piping connections are 1-1/2" MNPT. Use appropriate thread sealant and backup wrench when making connections.
- Step 2** Connect adapter assemblies to the panel. The supplied washers must be used, and nuts must not be overtightened as this may damage the washers.

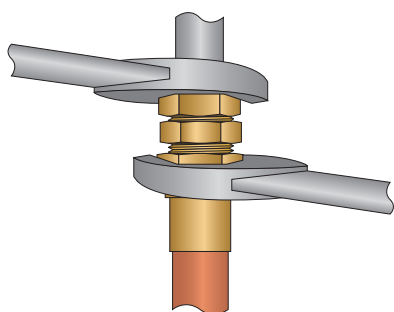
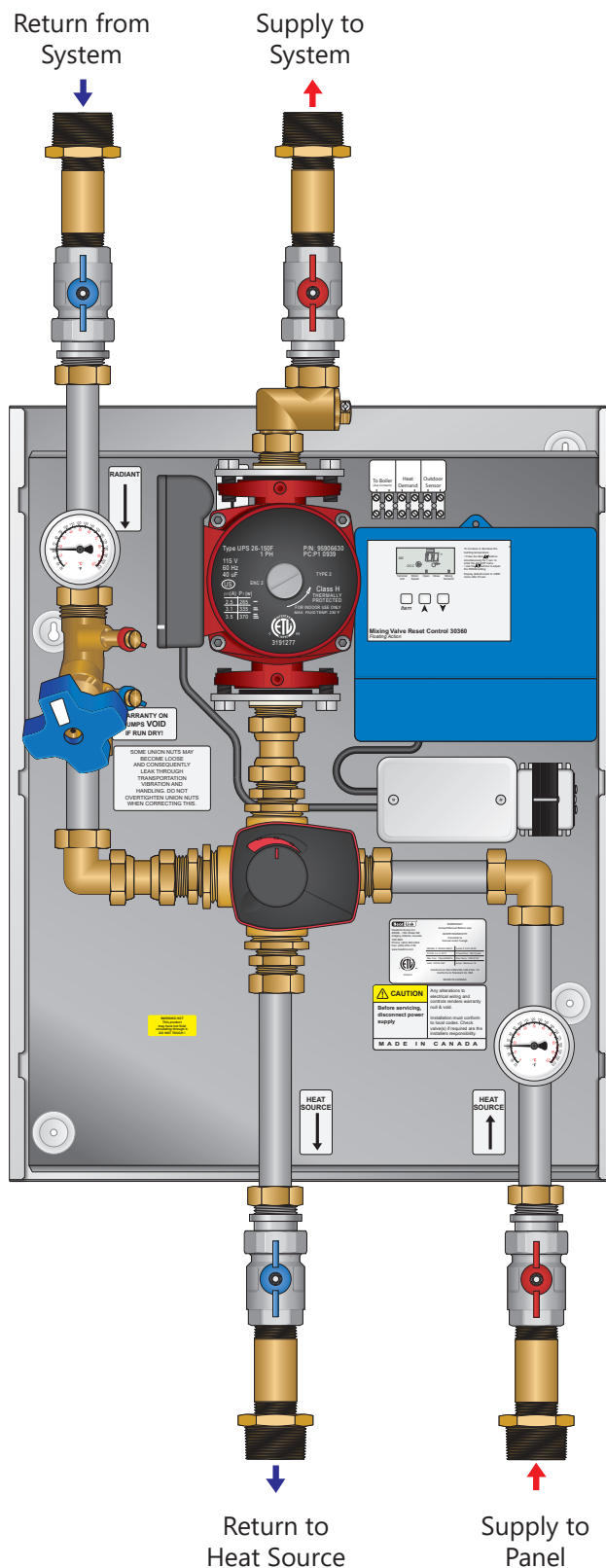

*Always use a Backup Wrench  
Do not overtighten brass nuts!*

Fill & Purge

- Step 1 Ensure the panel is not plugged in.
- Step 2 Fully open the mixing valve (fig. B)
- Step 3 Close all isolation ball valves, and attach the fill and purge hoses (not included) to the system fill and purge valves. Open valves.
- Step 4 Open isolation valves and allow water to run until it is free of bubbles.
- Step 5 Close system fill and purge valves.
- Step 6 Detach fill and purge hoses.
- Step 7 Check for leaks at connections. If any leaks are found, use a back-up wrench and carefully tighten until the leak stops. **Do not overtighten!**

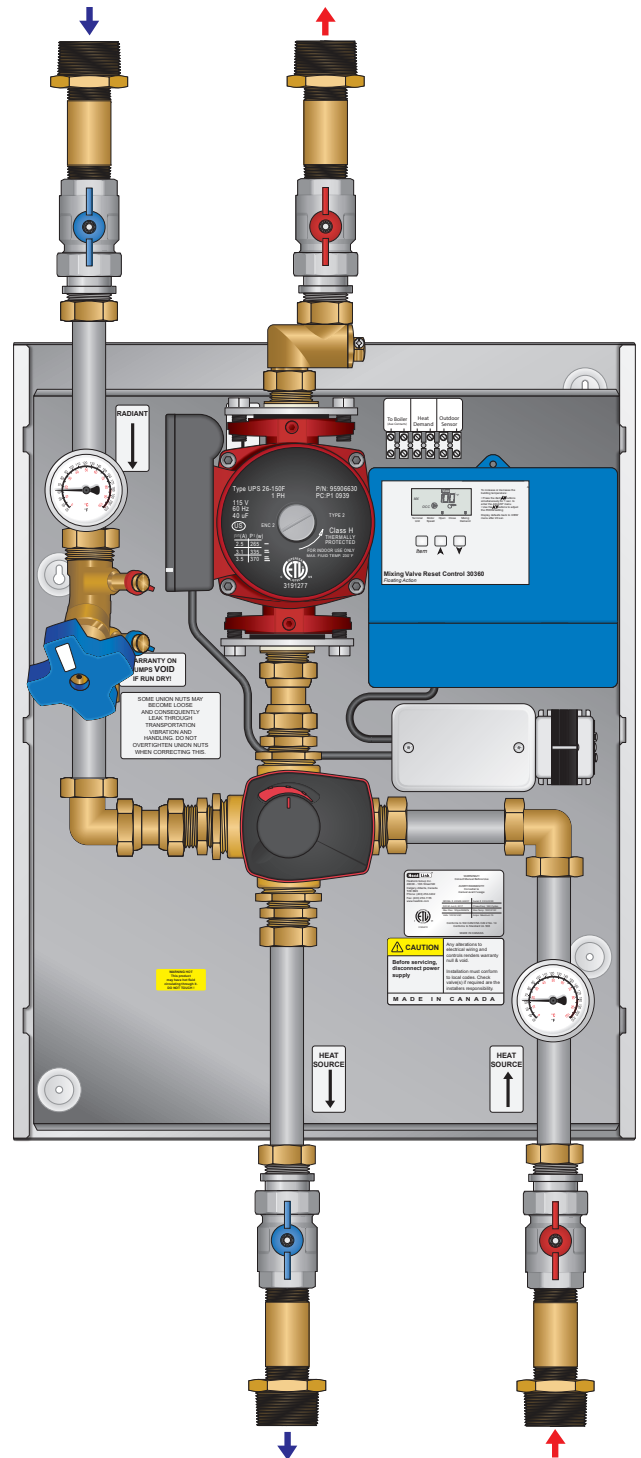

## Piping Options

### Option #1: Parallel Primary/Secondary

- |  |   |
|--|---|
| <p><b>Pros:</b></p> <ul style="list-style-type: none"> <li>• Supply water temperature the same for each load</li> <li>• No possible pump interference</li> </ul> | <p><b>Cons:</b></p> <ul style="list-style-type: none"> <li>• Requires additional balancing valves for each load take off.</li> <li>• Hot water migration/gravity flow possible in return riser. Flow check, Spring loaded check valve or thermal trap required in return riser.</li> <li>• Critical on site installation (Tee spacing and pipe sizing)</li> <li>• Complex piping</li> </ul> |
|--|---|

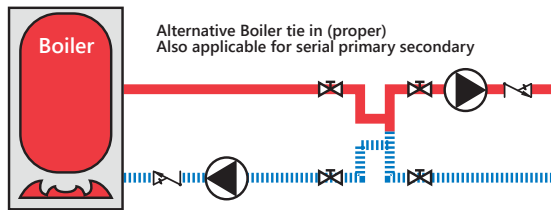
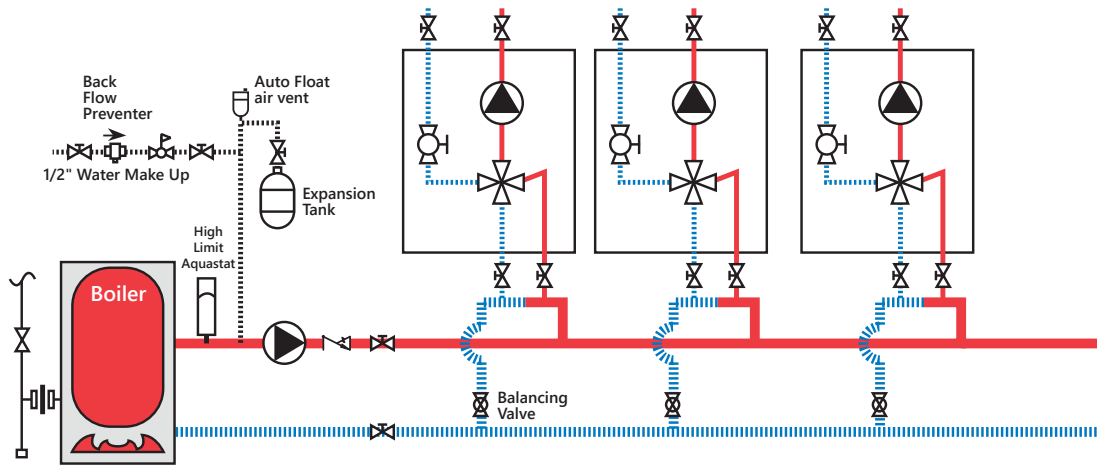

Proper Primary/Secondary piping (shown as alternative boiler tie in), requires an additional pump and triple (rather than the much more common double) pole relays (see page 22).

### Option #2: Series Primary/Secondary

- |   |  |
|---|--|
| <p><b>Pros:</b></p> <ul style="list-style-type: none"> <li>• Automatic priority</li> <li>• No possible pump interference</li> </ul> | <p><b>Cons:</b></p> <ul style="list-style-type: none"> <li>• Supply water temperature lowers for each load, this change of temperature is not constant. Some loads may not function if temperature is too low.</li> <li>• Very expensive to alter priority sequence (note: all loads are prioritized)</li> <li>• Hot water migration/gravity flow possible in return line. Flow check, Spring loaded check valve or thermal trap required in return riser.</li> <li>• Critical on site installation (Tee spacing and pipe sizing)</li> </ul> |
|---|--|

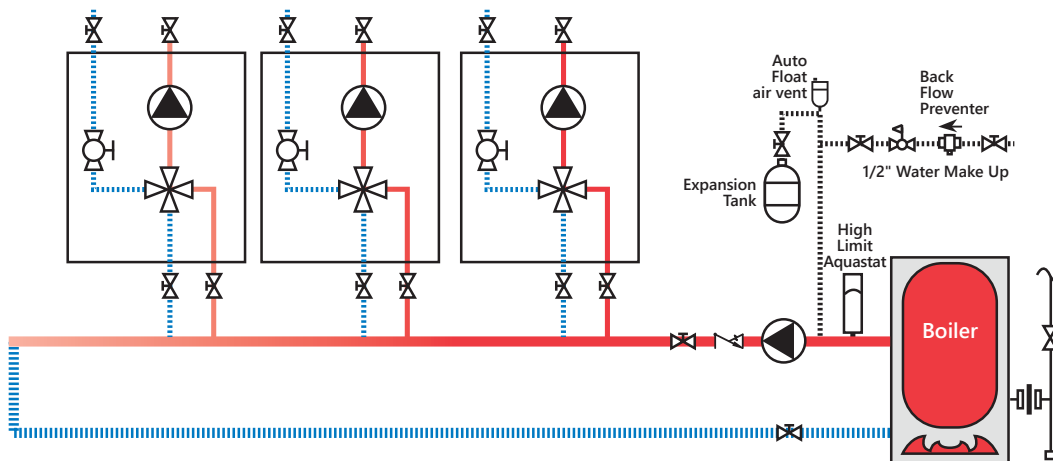

Panel Wiring



- Wiring should be done by a qualified electrician and should meet local codes and jurisdictions.

**Auxiliary Contacts** The auxiliary contact set is dry, meaning no supply of power is present at the terminal. The maximum allowable load is 1.5A. The auxiliary dry contact located on the terminal is to switch another device (ie. the heat source) when there is a call for heat from any zone.

Wiring Diagram

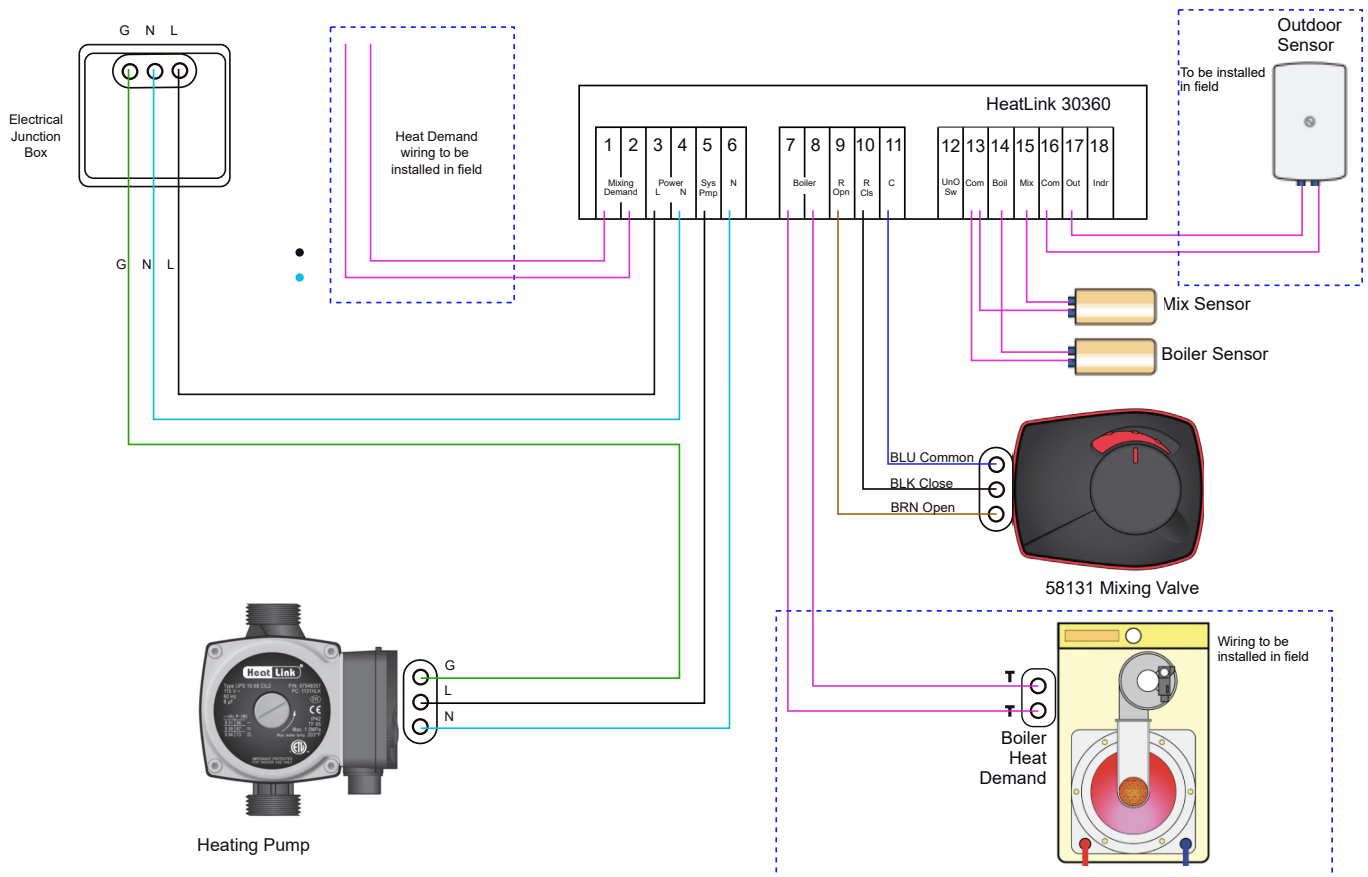

Panel Control Sequence

- Step 1 When the thermostat sends a demand for heat, the reset control ① closes the boiler contacts, turning on the boiler.
- Step 2 The pump ② is then activated, and circulates the system water.
- Step 3 The mixing valve motor ③ will open or close the mixing valve to adjust the supply water temperature.
- Step 4 Once the heat demand has been satisfied, the heat demand contact open, the boiler contacts open and the boiler turns off, and the pump turns off.

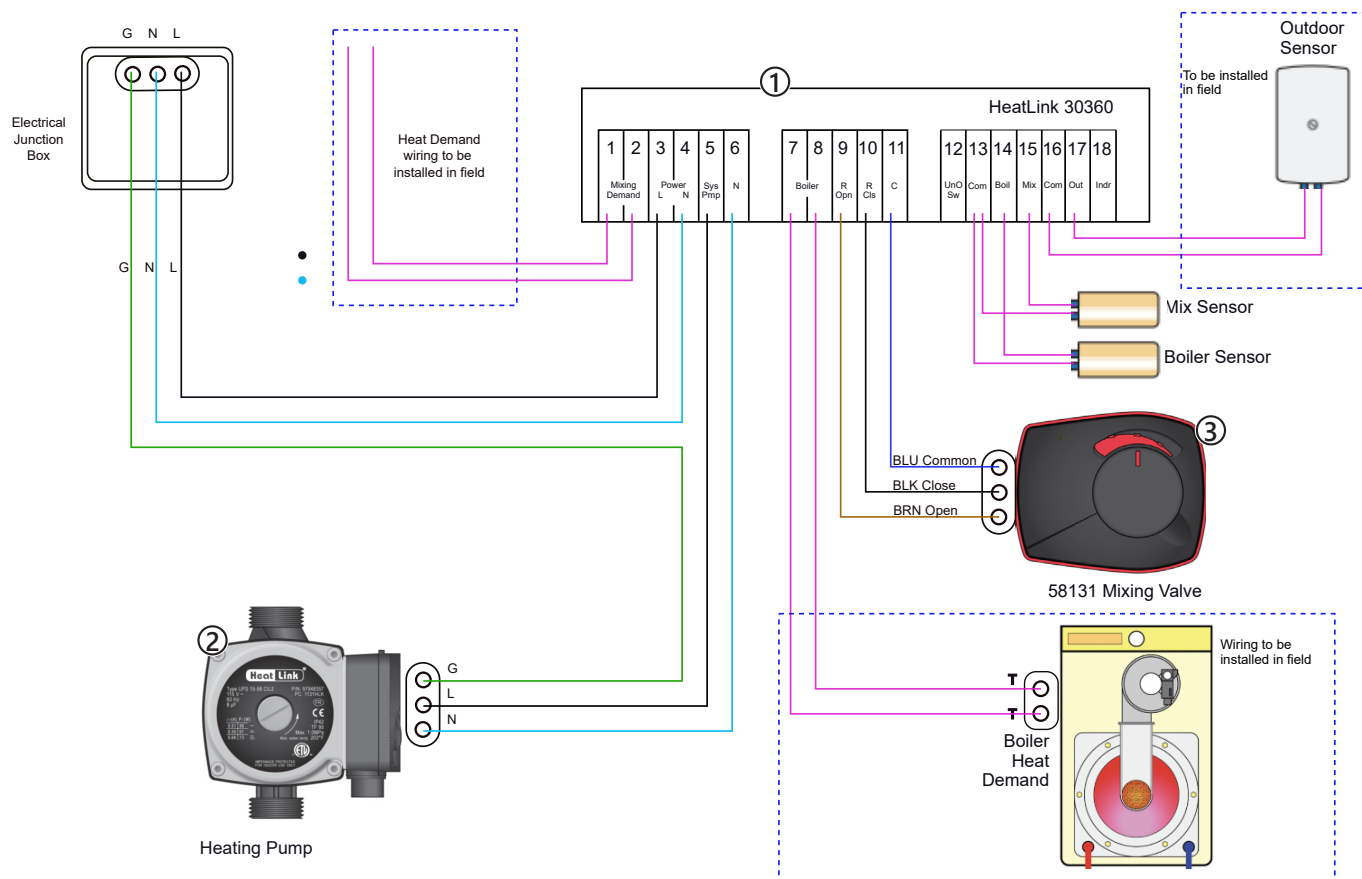

## Reset Control Overview

### User Interface

The 360 uses a Liquid Crystal Display (LCD) as the method of supplying information. You use the LCD in order to set up and monitor the operation of your system. The 360 has three push buttons (*Item*, ▲, ▼) for selecting, viewing, and adjusting settings. As you program your control, record your settings in the ADJUST menu table which is found in the second half of this brochure.

#### Item

The abbreviated name of the selected item will be displayed in the item field of the display. To view the next available item, press and release the *Item* button. Once you have reached the last available item, pressing and releasing the *Item* button will return the display to the first item.



#### Adjust

To make an adjustment to a setting in the control, press and hold simultaneously for 1 second all 3 buttons. The display will then show the word ADJUST in the top right corner. Then select the desired item using the *Item* button. Finally use the ▲ and/or ▼ button to make the adjustment.



To exit the ADJUST menu, either select the ESC item and press the ▲ or ▼ button, or leave the adjustment buttons alone for 20 seconds.

When the *Item* button is pressed and held in the VIEW menu, the display scrolls through all the adjust items in both access levels.

Additional information can be gained by observing the status field and pointers of the LCD. The status field will indicate which of the control's outputs are currently active. Most symbols in the status field are only visible when the VIEW menu is selected.

### Display

#### Item Field

Displays an abbreviated name of the selected item

#### Number Field

Displays the current value of the selected item

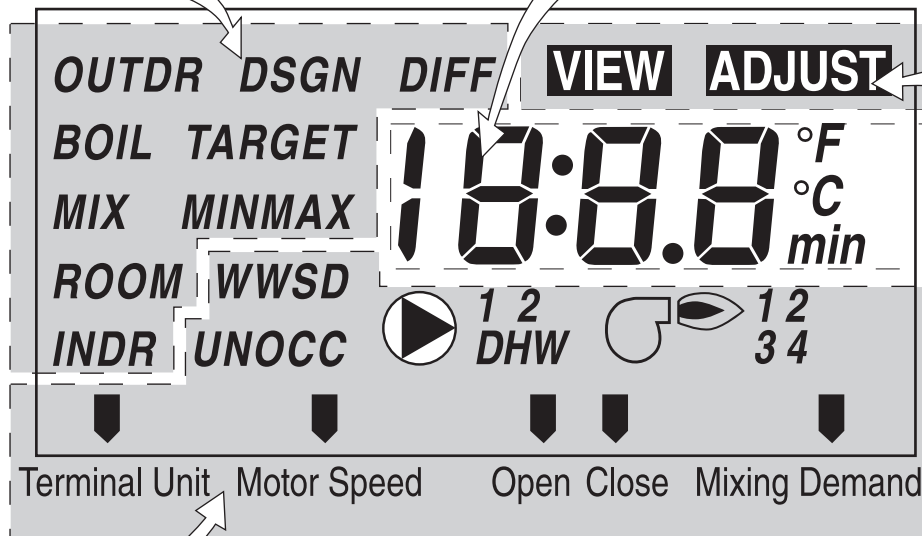

**Menu Field**  
Displays the current menu

#### Status Field

Displays the current status of the control's inputs, outputs and operation

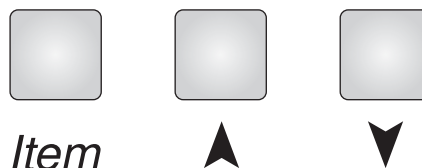



#### Buttons

Selects Menus, Items and adjusts settings



## Symbol Description

	<b>Pump</b> Displays when the mixing system pump is in operation.	<b>UNOCC</b>	<b>Unoccupied Schedule</b> Displays when the control is in unoccupied (Night) mode.
	<b>Burner</b> Displays when the boiler relay is turned on.	<b>°F, °C</b>	Displays the unit of measure that all of the temperatures are to be displayed in the control.
<b>OCC</b>	<b>Occupied Schedule</b> Displays when the control is in occupied (Day) mode.		<b>Pointer</b> Displays the control operation as indicated by the text.

## General Operation

### POWERING UP THE CONTROL

When the Mixing Control 360 is powered up, the control displays the control type number in the LCD for 2 seconds. Next, the software version is displayed for 2 seconds. Finally, the control enters into the normal operating mode.

### OPERATION

The 360 uses a floating action mixing valve to vary the supply water temperature to a hydronic system. The supply water temperature is based on either the current outdoor temperature, or a fixed setpoint.

#### Outdoor Reset

When the outdoor design (OUTDR DSGN) setting is not set to OFF, the 360 calculates a mixing supply water temperature based on the outdoor air temperature. The 360 uses a *Characterized Heating Curve* and optionally indoor temperature feedback from an indoor sensor in this calculation.

#### Setpoint Control

When the outdoor design (OUTDR DSGN) setting is set to OFF, the 360 supplies a fixed mixing supply temperature equal to the MIX TARGET setting. An outdoor sensor is not required during this mode of operation.

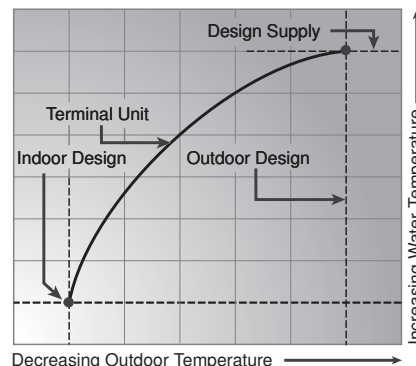

### FLOATING ACTION

A 24 V (ac) floating action actuator motor is connected directly to the 360 on the *R Opn*, *R Cls*, and *C* terminals (9,10 and 11). The 360 pulses the actuator motor open or close to maintain the correct mixed supply water temperature at the mix sensor when there is a mixing demand. The mixing valve that the actuator is connected to can be either a 2-way, 3-way, or 4-way valve. A visual indication as to whether the control is currently opening or closing the mixing valve is displayed in the LCD.

### BOILER PROTECTION (BOIL MIN)

The 360 is capable of providing boiler protection from cold mixing system return water temperatures. If the boiler sensor temperature is cooler than the BOIL MIN setting while the boiler is firing, the 360 reduces the output to the mixing valve. This limits the amount of cool return water to the boiler and allows the boiler temperature to recover. This feature can only be used if a boiler sensor is installed.

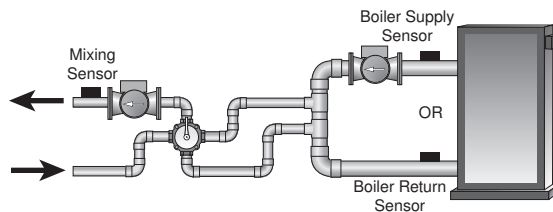

### EXERCISING

The 360 has a built-in exercising function. If the system pump or valve has not been operated at least once every 3 days, the control turns on the output for a minimum of 10 seconds. This minimizes the possibility of a pump or valve seizing during a long period of inactivity. The 360 ensures that the mixing valve operates over its entire range at least once each exercising period. While the control is exercising the *Test* LED flashes.

**Note:** The exercising function does not work if power to the control, pump, or valve is disconnected.

## SETBACK (UNOCCUPIED)

To provide greater energy savings, the 360 has a setback capability. With setback, the supply water temperature in the system is reduced when the building is unoccupied. By reducing the supply water temperature, air temperature in the space may be reduced even when thermostat(s) are not turned down. Any time the *UnO Sw* (12) and the *Com* (13) terminals are shorted together, the control operates in the unoccupied (Night) mode. When in the unoccupied (Night) mode, the UNOCC segment is displayed in the LCD. The 360 adjusts the supply water temperature based on the UNOCC settings made in the control. This feature has no effect when the control is used as a setpoint control.

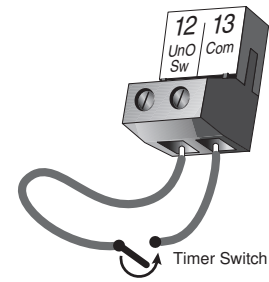

## FACTORY DEFAULTS

The control comes preset with several factory defaults. These defaults are based on the terminal unit selection (see section B2). To fine-tune building requirements, these defaults may be changed. If a factory default value for a terminal unit is changed, the terminal unit number will flash when selected in the ADJUST menu.

To reload the factory defaults listed in section B2, power down the control and wait for 10 seconds. Power up the control while simultaneously holding the **Item** and **▼** buttons. The terminal unit number should now be displayed constantly in the LCD rather than flashing.

## Mixing

### MIXING DEMAND

A mixing demand is required in order for the 360 to provide heat. A mixing demand is generated by applying a voltage between 24 and 240 V (ac) across the *Mixing Demand* terminals (1 and 2). Once voltage is applied, the *Mixing Demand* pointer is displayed in the LCD. If the 360 is not in WWSD, the 360 closes the *Sys Pmp* contact. The 360 calculates a MIX TARGET supply temperature based on the outdoor air temperature and settings. If required, the 360 operates the boiler in order to provide heat to the mixing valve.

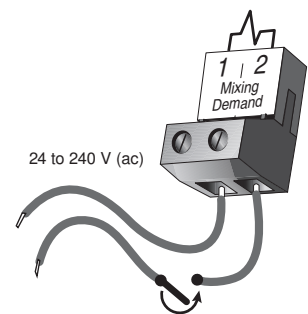

### SYSTEM PUMP OPERATION (SYS PMP)

The system pump contact (*Sys Pmp*, terminal 5) closes whenever there is a mixing demand and the 360 is not in WWSD. The system pump segment is displayed in the LCD. After the mixing demand has been satisfied, the 360 continues to operate the system pump for 20 seconds. This allows some residual heat to be purged out to the heating system. During WWSD, the system pump is operated based on the exercise function.

### INDOOR SENSOR

An indoor sensor may be used in order to provide indoor temperature feedback. The indoor sensor is connected to the *Com* and *Indr* terminals (16 and 18). In addition, power must be applied to the *Mixing Demand* terminals (1 and 2) as described in the MIXING DEMAND section. With the indoor sensor connected, the 360 is able to sense the actual room temperature. Indoor temperature feedback fine-tunes the supply water temperature in the mixing system to maintain room temperature. To adjust the room temperature, use the ROOM OCC or ROOM UNOCC setting in the ADJUST menu at the control.

If a multiple zone system is used with an indoor sensor, proper placement of the indoor sensor is essential. The indoor sensor should be located in an area which best represents the average air temperature of the zones.

### CHARACTERIZED HEATING CURVE

When used as a mixing reset control, the 360 varies the supply water temperature based on the outdoor air temperature. The control takes into account the type of terminal unit that the system is using. Since different types of terminal units transfer heat to a space using different proportions of radiation, convection and conduction, the supply water temperature must be controlled differently. Once the control is told what type of terminal unit is used, the control varies the supply water temperature according to the type of terminal unit. This improves the control of the air temperature in the building.

### MIXING TARGET TEMPERATURE (MIX TARGET)

When used as a mixing reset control, the MIX TARGET temperature is calculated from the *Characterized Heating Curve* settings, outdoor air temperature and optionally, indoor air temperature. When used as a setpoint control, the installer sets the MIX TARGET temperature. The control displays the temperature that it is currently trying to maintain as the mixing supply temperature. If the control does not have a mixing demand, "- -" is displayed as the MIX TARGET.

## Boiler Operation

### BOILER OPERATION

When the 360 determines that boiler operation is required, the *Boiler* contact terminals (7 and 8) close. While the *Boiler* contact is closed, the burner segment in the LCD is displayed.

### BOILER MINIMUM (BOIL MIN)

Most boilers require a minimum water temperature in order to prevent flue gas condensation. The BOIL MIN adjustment is set to the boiler manufacturer's minimum recommended operating temperature. Only when the boiler temperature is measured by a boiler sensor can the 360 provide boiler protection. In this case when the boiler is firing and the boiler temperature is below the BOIL MIN Setting the 360 turns on the MIN segment and reduces the heating load on the boiler by limiting the output of the mixing valve. If the installed boiler is designed for low temperature operation, set the BOIL MIN adjustment to OFF.

### BOILER PROTECTION

Refer to section A for a description of boiler protection.

## Boiler Sensor Placement

### BOILER SENSOR ON THE SUPPLY (Boiler Sensor DIP switch = Supply)

The boiler sensor can be located on the boiler supply if the 360 is the only control that is operating the boiler. When in the supply mode, the 360 determines the required operating temperature of the boiler using *Boiler Load Reset*. With *Boiler Load Reset*, the 360 operates the boiler at the lowest possible supply temperature that is sufficient to satisfy the requirements of the mixing valve. If this mode of operation is selected, the boiler pump should either operate continuously, or be operated in parallel with the system pump contact (*Sys Pmp*).

**Note:** The boiler pump should not be operated by the boiler's aquastat, as this may lead to improper cycling of the boiler because of inconsistent flow past the boiler supply sensor.

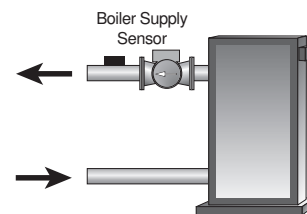

### BOILER DIFFERENTIAL (BOIL DIFF)

An on / off heat source such as a boiler must be operated with a differential in order to prevent short cycling. When the boiler supply temperature drops below the bottom rail of the differential, the 360 closes the *Boiler* contact to fire the boiler. When the boiler supply temperature rises above the top rail of the differential, the 360 opens the *Boiler* contact to turn off the boiler. With the 360, either a fixed or automatic differential setting is selected. If automatic differential (**Ad**) is selected, the 360 automatically adjusts the boiler differential under the current load conditions to avoid short cycling.

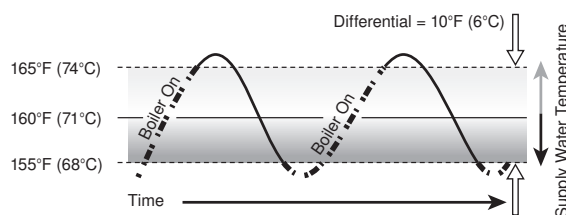

### BOILER SENSOR ON THE RETURN (Boiler Sensor DIP switch = Return)

The boiler sensor should be located on the boiler return if the 360 is one of many controls that can call for boiler operation. When in the return mode, the 360 provides a boiler enable as described in the BOILER ENABLE section. The 360 no longer tries to control the boiler supply water temperature directly but allows the boiler to operate at its operating aquastat setting when required. If this mode of operation is selected, the boiler pump should either operate continuously or be operated in parallel with the system pump contact (*Sys Pmp*).

**Note:** The boiler pump should not be operated by the boiler's aquastat, as this may lead to improper cycling of the boiler because of inconsistent flow past the boiler return sensor.

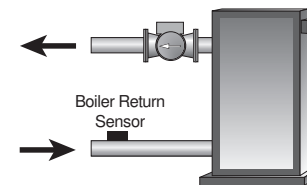

### NO BOILER SENSOR

The 360 is capable of operating without a boiler sensor if desired. Without a boiler sensor, the 360 provides a boiler enable as described in the BOILER ENABLE section, but is unable to provide boiler protection. This type of application is typical if the 360 is drawing heat from a heat source that already incorporates some form of boiler protection.

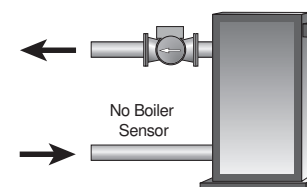

**BOILER ENABLE (30% Enable / 10% Enable)**

The 360 has a DIP switch that allows for the selection between a 30% boiler enable and a 10% boiler enable. This switch is only functional when the *Boiler Sensor* DIP switch is set to *Return*.

In the 30% position, the 360 closes the *Boiler* contact when the position of the mixing valve exceeds 30%. The *Boiler* contact remains closed until the position of the mixing valve reduces below 15%. This setting would normally be chosen for low mass boilers (copper fin-tube, etc.) or systems with low thermal mass in the loop between the boiler and the mixing valve.

In the 10% position, the 360 closes the *Boiler* contact when the position of the mixing valve exceeds 10%. The *Boiler* contact remains closed until the position of the mixing valve reduces below 5%. This setting is normally chosen for high mass boilers (cast iron, steel, fire-tube, etc.) or systems with large thermal mass in the loop between the boiler and the mixing valve.

In order to prevent short cycling, the *Boiler* contact has a minimum on time, and a minimum off time.

**Setup****DIP Switch Settings**

The DIP Switch settings on the control are very important and should be set to the appropriate settings prior to making any adjustments to the control through the user interface. The DIP switch settings change the items that are available to be viewed and / or adjusted in the user interface.

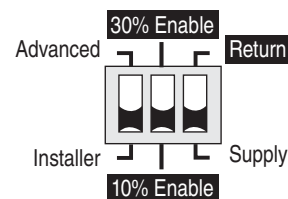
**ADVANCED / INSTALLER**

The *Advanced / Installer* DIP switch is used to select which items are available to be viewed and / or adjusted in the user interface.

**30% ENABLE / 10% ENABLE**

The position of the *30% Enable / 10% Enable* DIP switch determines at which valve position the control will close the Boiler contact under normal conditions. This switch is only operational if the *Boiler Sensor* DIP switch is set to *Return*.

**BOILER SENSOR (RETURN / SUPPLY)**

The Boiler Sensor DIP switch selects the installation location for the boiler sensor. When the boiler sensor is installed on the supply side of the boiler loop, the DIP switch must be set to *Supply*. The boiler aquastat should be set at least 20 °F (11 °C) higher than the required design boiler water temperature. The boiler is controlled as described in section C.

For systems where the 360 provides a heat demand to an external boiler control, the boiler sensor should be installed on the return side of the boiler loop. When the boiler sensor is installed on the return side of the boiler loop, the DIP switch must be set to *Return*. The 360 enables the boiler when the position of the mixing valve exceeds the boiler enable DIP switch setting. The Boiler contact is controlled as described in section C. The boiler's operating temperature is controlled by its aquastat, or an external boiler reset control.

## Quick Setup

The quick setup can be used for both outdoor reset and setpoint operation. To enter the installer programming mode, set the *Advanced / Installer* DIP switch to *Installer*.

### OUTDOOR RESET

Access the ADJUST menu by pressing and holding simultaneously for 1 second, all 3 buttons. The display will now show the word ADJUST in the top right corner.

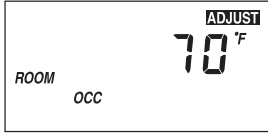

The ROOM OCC adjustment is the first item displayed. Use the ▲ or ▼ button to set the ROOM temperature. The ROOM OCC setting is set to the desired room air temperature during the occupied (Day) mode.  
**Note:** To increase or decrease space temperature during the occupied (Day) mode, only adjust the ROOM OCC setting.

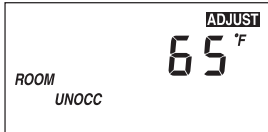

Press and release the *Item* button to advance to the ROOM UNOCC adjustment. Use the ▲ or ▼ button to set the desired temperature. The ROOM UNOCC setting is set to the desired room air temperature during the unoccupied (Night) mode.  
**Note:** To increase or decrease space temperature during the unoccupied (Night) mode, only adjust the ROOM UNOCC setting.

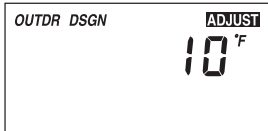

Press and release the *Item* button to advance to the OUTDR DSGN adjustment. Use the ▲ or ▼ button to set the outdoor design temperature. The OUTDR DSGN setting is set to the typical coldest temperature of the year.



Press and release the *Item* button to advance to the *Terminal Unit* adjustment. Use the ▲ or ▼ button to select the desired terminal unit. The terminal unit number corresponds to the type of terminal that is being used. The table below lists the terminal units and their default values.

Terminal Unit	High Mass Radiant (1)	Low Mass Radiant (2)	Fancoil (3)	Fin-tube Convectector (4)	Radiator (5)	Baseboard (6)
MIX DSGN	120°F (49°C)	140°F (60°C)	190°F (88°C)	180°F (82°C)	160°F (71°C)	150°F (66°C)
MIX MAX	140°F (60°C)	160°F (71°C)	210°F (99°C)	200°F (93°C)	180°F (82°C)	170°F (77°C)
MIX MIN	OFF	OFF	100°F (38°C)	OFF	OFF	OFF



Press and release the *Item* button to advance to the units adjustment. Use the ▲ or ▼ button to set the scale to °F or °C.

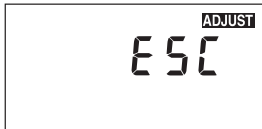

To exit the ADJUST menu, press and release the *Item* button to advance to the ESC item. Then either press the ▲ or ▼ button, or leave the buttons alone for 20 seconds.

**SETPOINT CONTROL**

Access the ADJUST menu by pressing and holding simultaneously for 1 second, the *Item*, ▲ and ▼ buttons. The display will now show the word ADJUST in the top right corner.

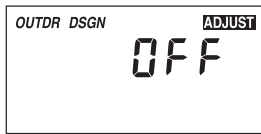

Press and release the *Item* button to advance to the OUTDR DSGN adjustment. Press and hold the ▲ button until OFF is displayed.



Press and release the *Item* button to advance to the MIX TARGET adjustment. Use the ▲ or ▼ button to select the desired temperature. The MIX TARGET setting is set to the desired setpoint supply temperature.



Press and release the *Item* button to advance to the units adjustment. Use the ▲ or ▼ button to set the scale to °F or °C.

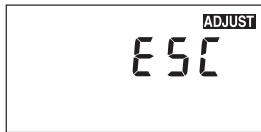

To exit the ADJUST menu, press and release the *Item* button to advance to the ESC item. Then either press the ▲ or ▼ button, or leave the buttons alone for 20 seconds.

**View Menu (1 of 1)**

Display	Section			Description	Range
	Section	Installer	Advanced		
<p>OUTDR 50 °F OCC</p>		●	●	Current outdoor air temperature as measured by the outdoor sensor. This is also the default display for the control. (OUTDR DSGN ≠ OFF)	-67 to 149 °F (-55 to 65 °C)
<p>ROOM 68 °F OCC</p>	B1	●	●	Current room air temperature as measured by the indoor sensor. (Indoor Sensor is present)	23 to 113 °F (-5 to 45 °C)
<p>MIX 100 °F OCC</p>	B3	●	●	Current mixed supply water temperature as measured by the mixing sensor	14 to 266 °F (-10 to 130 °C)
<p>MIX TARGET 110 °F OCC</p>	B1 B2 B3	●	●	Target mixed supply is the temperature the control is currently trying to maintain at the mixing sensor.	---, 14 to 266 °F (---, -10 to 130 °C)
<p>BOIL 150 °F OCC</p>		●	●	Current boiler temperature as measured by the boiler sensor. (Boiler sensor is present)	14 to 266 °F (-10 to 130 °C)

Adjust Menu (1 of 2)

Display	Section			Description	Range	Actual Setting
	Installer	Advanced				
ROOM OCC 70 <sup>F</sup> ADJUST	B2	<input type="radio"/>	<input checked="" type="radio"/>	The desired room air temperature during an occupied (Day) period. <b>(OUTDR DSGN ≠ OFF)</b>	35 to 100°F (2 to 38°C)	
ROOM UNOCC 65 <sup>F</sup> ADJUST	B2	<input type="radio"/>	<input checked="" type="radio"/>	The desired room air temperature during an unoccupied (Night) period. <b>(OUTDR DSGN ≠ OFF)</b>	35 to 100°F (2 to 38°C)	
TARGET MIX 98 <sup>F</sup> ADJUST	B2	<input type="radio"/>	<input checked="" type="radio"/>	Mixing setpoint temperature. <b>(OUTDR DSGN = OFF)</b>	60 to 200°F (16 to 93°C)	
OUTDR DSGN 10 <sup>F</sup> ADJUST	B2	<input type="radio"/>	<input checked="" type="radio"/>	The design outdoor air temperature used in the heat loss calculation for the heating system. For setpoint operation, set the OUTDR DSGN to OFF	-60 to 32°, OFF (-51 to 0°C, OFF)	
Terminal Unit 1 ADJUST	B2	<input type="radio"/>	<input checked="" type="radio"/>	The type of terminal units that are being used in the heating system. <b>(OUTDR DSGN ≠ OFF)</b>	1 (High Mass Radiant) 2 (Low Mass Radiant) 3 (Fancoil) 4 (Fin-tube Convector) 5 (Radiator) 6 (Baseboard)	
MIX INDR 70 <sup>F</sup> ADJUST	B3	<input checked="" type="radio"/>	<input type="radio"/>	The design indoor air temperature used in the heat loss calculation for the heating system. <b>(OUTDR DSGN ≠ OFF)</b>	35 to 100°F (2 to 38°C)	
DSGN MIX 120 <sup>F</sup> ADJUST	B3	<input checked="" type="radio"/>	<input type="radio"/>	The design supply water temperature used in the heat loss calculation for the heating system. <b>(OUTDR DSGN ≠ OFF)</b>	70 to 220°F (21 to 104°C)	
MIX MAX 140 <sup>F</sup> ADJUST	B3	<input checked="" type="radio"/>	<input type="radio"/>	The maximum supply water temperature for the mixing system <b>(OUTDR DSGN ≠ OFF)</b>	80 to 210°F (27 to 99°C)	
Motor Speed 160 ADJUST	A	<input checked="" type="radio"/>	<input type="radio"/>	The time that the actuating motor requires to operate from fully closed to fully open.	30 to 230 seconds (1 sec. increments)	
MIX MIN OFF ADJUST	B3	<input checked="" type="radio"/>	<input type="radio"/>	The minimum supply temperature for the mixing system. <b>(OUTDR DSGN ≠ OFF)</b>	OFF, 35 to 150°F (OFF, 2 to 65°C)	
BOIL MIN 140 <sup>F</sup> ADJUST	C1	<input checked="" type="radio"/>	<input type="radio"/>	The minimum temperature allowed for the boiler target temperature. <b>(Boiler sensor is present)</b>	OFF, 80 to 180°F (OFF, 27 to 82°C)	

Adjust Menu (2 of 2)

Display	Section			Description	Range	Actual Setting
	Installer	Advanced				
	C2	●		The differential that the control is to use when it is operating the boiler. <b>(Boiler Sensor DIP switch = Supply AND Boiler sensor is present)</b>	Ad, 2 to 42°F (Ad, -17 to 6°C)	
	B3	●		The system's warm weather shut down during the occupied (Day) period.	35 to 100°F, OFF (2 to 38°C, OFF)	
	B3	●		The system's warm weather shut down during the unoccupied (Night) period.	35 to 100°F, OFF (2 to 38°C, OFF)	
		●	○	The units of measure that all of the temperatures are to be displayed in the control.	°F, °C	
		●	○	This item exits the ADJUST menu by pressing either the ▲ or ▼ button.		

Testing the Control

The Mixing Control 360 has a built-in test routine which is used to test the main control functions. The 360 continually monitors the sensors, and displays an error message whenever a fault is found. See the following pages for a list of the 360's error messages and possible causes. When the **Test** button is pressed, the test light is turned on. The individual outputs and relays are tested in the following test sequence.

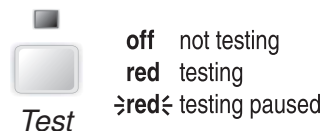

TEST SEQUENCE

Each step in the test sequence lasts 10 seconds.

During the test routine, the test sequence may be paused by pressing the **Test** button. Only if there is a mixing demand can the control be paused in a step. If the **Test** button is not pressed again for 5 minutes while the test sequence is paused, the control exits the entire test routine. If the test sequence is paused, the **Test** button can be pressed again to advance to the next step. This can also be used to rapidly advance through the test sequence. To reach the desired step, repeatedly press and release the **Test** button until the appropriate device and segment in the display turn on.

- Step 1 - The mixing valve is run fully open.
- Step 2 - The mixing valve is run fully closed, and then the system pump (*Sys Pmp*) is turned on.
- Step 3 - The *Boiler* contact is turned on for 10 seconds. After 10 seconds, the *Boiler* and *Sys Pmp* contacts are shut off.
- Step 4 - After the test sequence is completed, the control resumes its normal operation.



**Error Messages**



The control was unable to read a piece of information from its EEPROM. This error can be caused by a noisy power source. The control will load the factory defaults and stop operation until all the settings are verified.

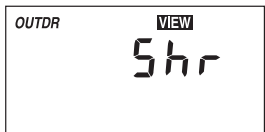

The control is no longer able to read the outdoor sensor due to a short circuit. In this case the control assumes an outdoor temperature of 32°F (0°C) and continues operation. Locate and repair the problem as described in the Data Brochure D 070. To clear the error message from the control after the sensor has been repaired, press the **Item** button.

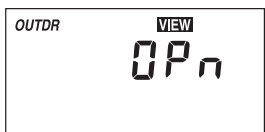

The control is no longer able to read the outdoor sensor due to an open circuit. In this case the control assumes an outdoor temperature of 32°F (0°C) and continues operation. Locate and repair the problem as described in the Data Brochure D 070. To clear the error message from the control after the sensor has been repaired, press the **Item** button.

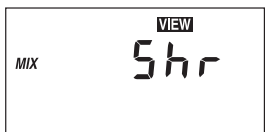

The control is no longer able to read the mixing supply sensor due to a short circuit. In this case the control will operate the mixing valve at a fixed output as long as there is a mixing demand. Locate and repair the problem as described in the Data Brochure D 070. To clear the error message from the control after the sensor has been repaired, press the **Item** button.

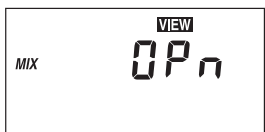

The control is no longer able to read the mixing supply sensor due to a short circuit. In this case the control will operate the mixing valve at a fixed output as long as there is a mixing demand. Locate and repair the problem as described in the Data Brochure D 070. To clear the error message from the control after the sensor has been repaired, press the **Item** button.

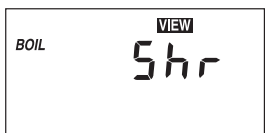

The control is no longer able to read the boiler sensor due to a short circuit. If the BOIL MIN adjustment is higher than 100°F (38°C), the control closes the Boiler contact when the mixing valve starts to operate. The boiler temperature is then limited by the operating aquastat. If the BOIL MIN adjustment is lower than 100°F (38°C), the control does not operate the Boiler contact. Locate and repair the problem as described in the Data Brochure D 070. To clear the error message from the control after the sensor has been repaired, press the **Item** button.

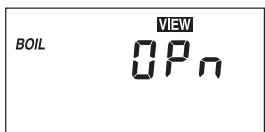

The control is no longer able to read the boiler sensor due to an open circuit. If the BOIL MIN adjustment is higher than 100°F (38°C), the control closes the Boiler contact when the mixing valve starts to operate. The boiler temperature is then limited by the operating aquastat. If the BOIL MIN adjustment is lower than 100°F (38°C), the control does not operate the Boiler contact. Locate and repair the problem as described in the Data Brochure D 070. If the boiler sensor is deliberately removed, the control must be powered down, and then powered back up. To clear the error message from the control after the sensor has been repaired, press the **Item** button.

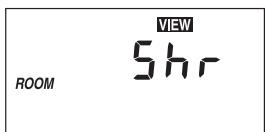

The control is no longer able to read the indoor sensor due to a short circuit. The control will continue to operate as if there was nothing connected to the indoor sensor input. Locate and repair the problem as described in the Data Brochure D 074. To clear the error message from the control after the sensor has been repaired, press the **Item** button.

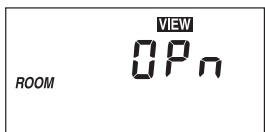

The control is no longer able to read the indoor sensor due to an open circuit. The control will continue to operate as if there was nothing connected to the indoor sensor input. Locate and repair the problem as described in the Data Brochure D 074. If the indoor sensor is deliberately removed, the control must be powered down, and then powered back up. To clear the error message from the control after the sensor has been repaired, press the **Item** button.

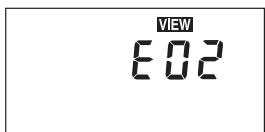

The control enclosure has overheated or control has an internal error. The control will stop operation until condition is corrected. Try resetting by powering down, waiting for 1 minute, and powering back up.

## Troubleshooting

Problem	Check / Verify	Possible Cause
Low System Water Temperature	The electronic actuator fails to open during a call for heat	The electronic actuator may be improperly seated or may be defective. Replace if necessary.
	Wiring from panel to control.	Check that the wiring is done properly. Consult qualified electrician prior to alteration of wiring between heat source and panel.
	Output of heat source is unable to meet demand of heating system.	Compare output of heat source to the requirements of the heating system.
	Circulator is not on during a call for heat. (Use a stethoscope or similar device to verify)	The circulator may be defective.
	Boiler is locked out.	Reset boiler.



